

UCFL 203 ASAHI

Ball bearing units

TYPE: Housing units, Two-bolt flanged housing units, Cast iron housing, Radial insert ball bearing with grub screws in inner ring, Type UCFL (ASAHI)

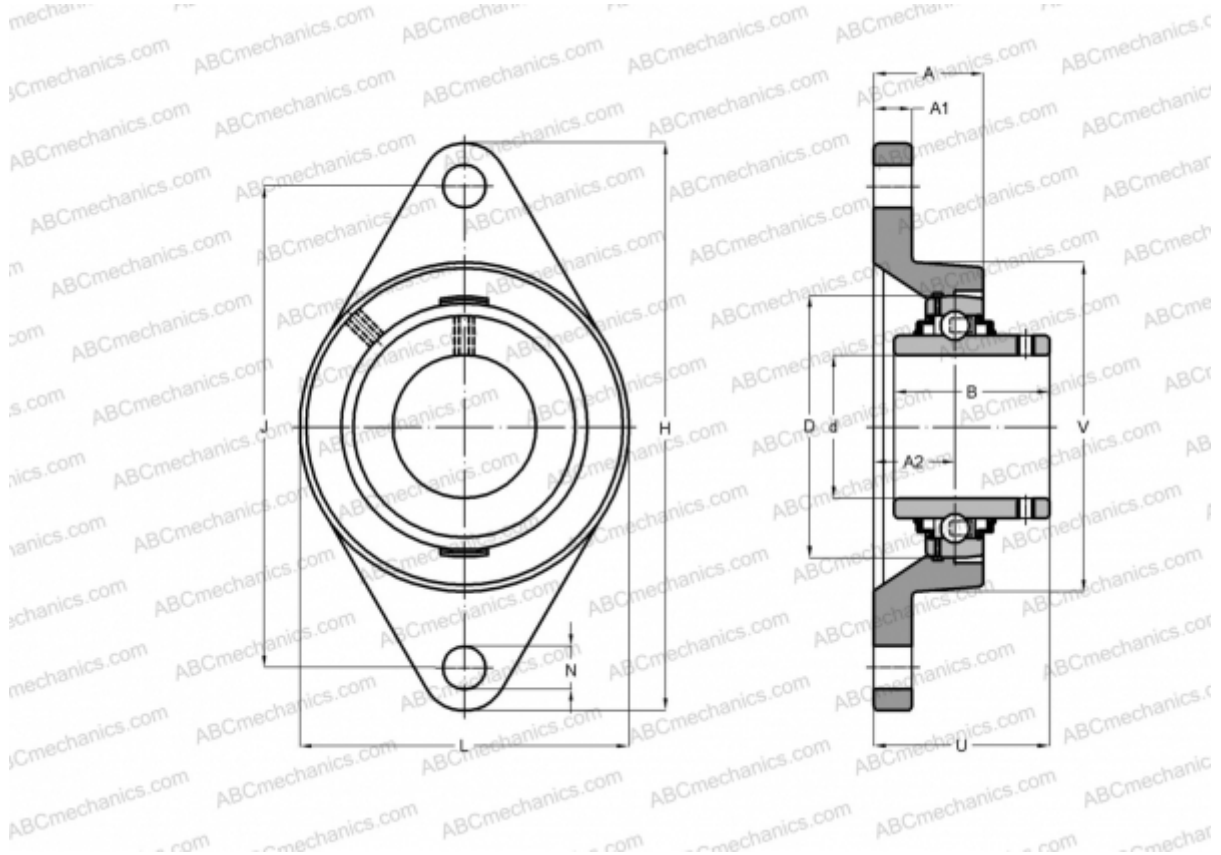

Technical specification

DIMENSIONS, MM

d	17,000
D	47,000
B	31,000
L	60,000
H	113,000
A	25,500
J	90,000
A1	12,000
A2	12,700
N	12,000
U	33,300

WEIGHT, KG

	0,470
Bearing	UC 203

Housing

FL 204

MANUFACTURER

[ASAHI](#)