

UCFL 205 ASAHI

Ball bearing units

TYPE: Housing units, Two-bolt flanged housing units, Cast iron housing, Radial insert ball bearing with grub screws in inner ring, Type UCFL (ASAHI)

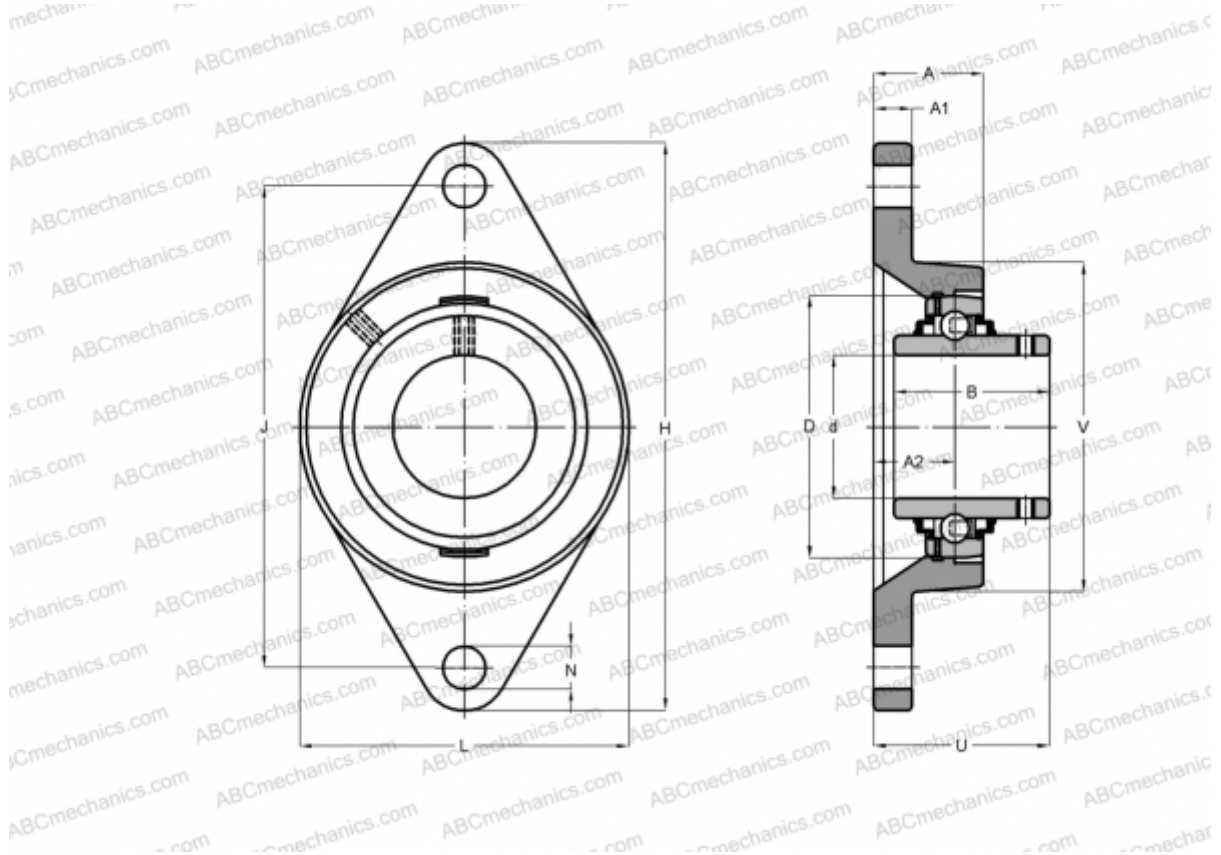

Technical specification

DIMENSIONS, MM

d	25,000
D	52,000
B	34,100
L	68,000
H	130,000
A	27,000
J	99,000
A1	14,000
A2	14,300
N	16,000
U	35,700

WEIGHT, KG

	0,630
Bearing	UC 205

Housing

FL 205

MANUFACTURER

[ASAHI](#)