

UCFL 206 ASAHI

Ball bearing units

TYPE: Housing units, Two-bolt flanged housing units, Cast iron housing, Radial insert ball bearing with grub screws in inner ring, Type UCFL (ASAHI)

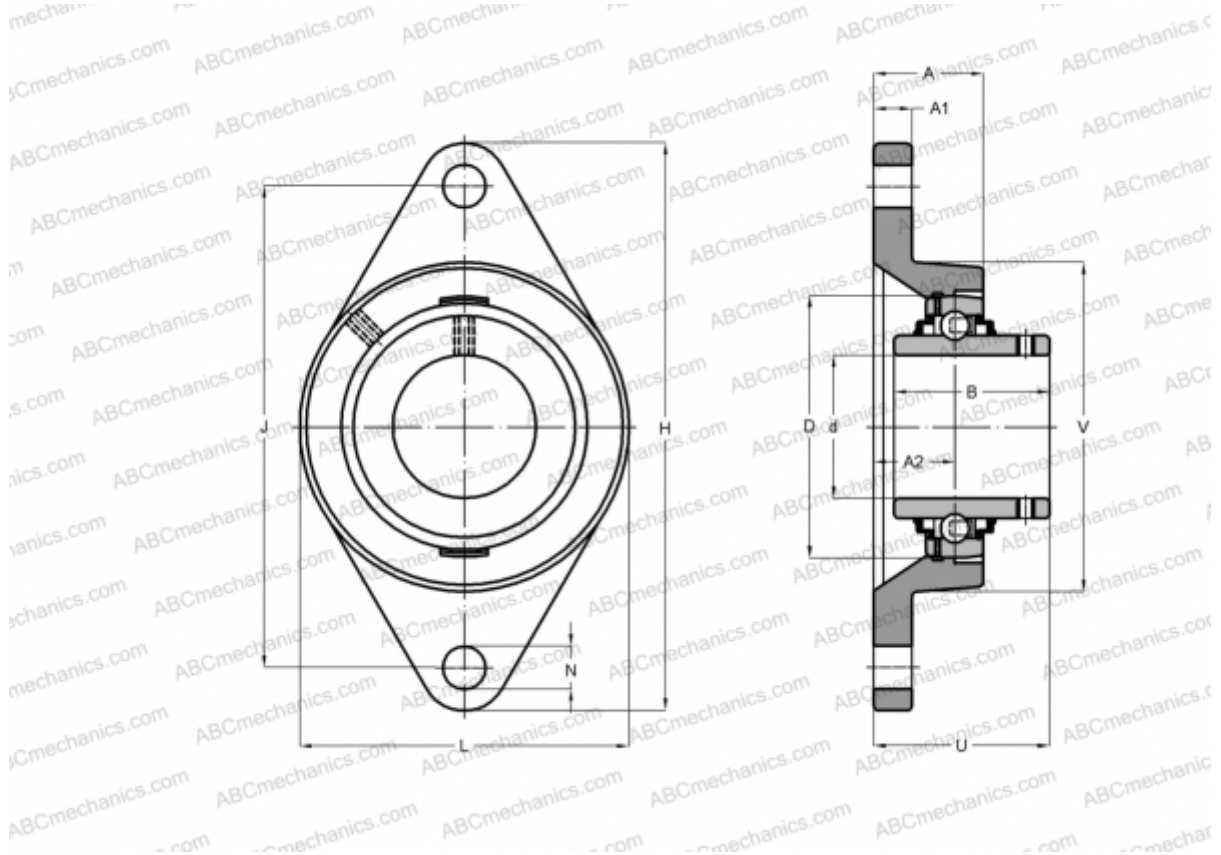

Technical specification

DIMENSIONS, MM

d	30,000
D	62,000
B	38,100
L	80,000
H	140,000
A	31,000
J	117,000
A1	14,000
A2	15,900
N	16,000
U	40,200

WEIGHT, KG

Bearing	UC 206
Housing	FL 206

Housing

FL 206

MANUFACTURER

[ASAHI](#)