

UCFL 207 ASAHI

Ball bearing units

TYPE: Housing units, Two-bolt flanged housing units, Cast iron housing, Radial insert ball bearing with grub screws in inner ring, Type UCFL (ASAHI)

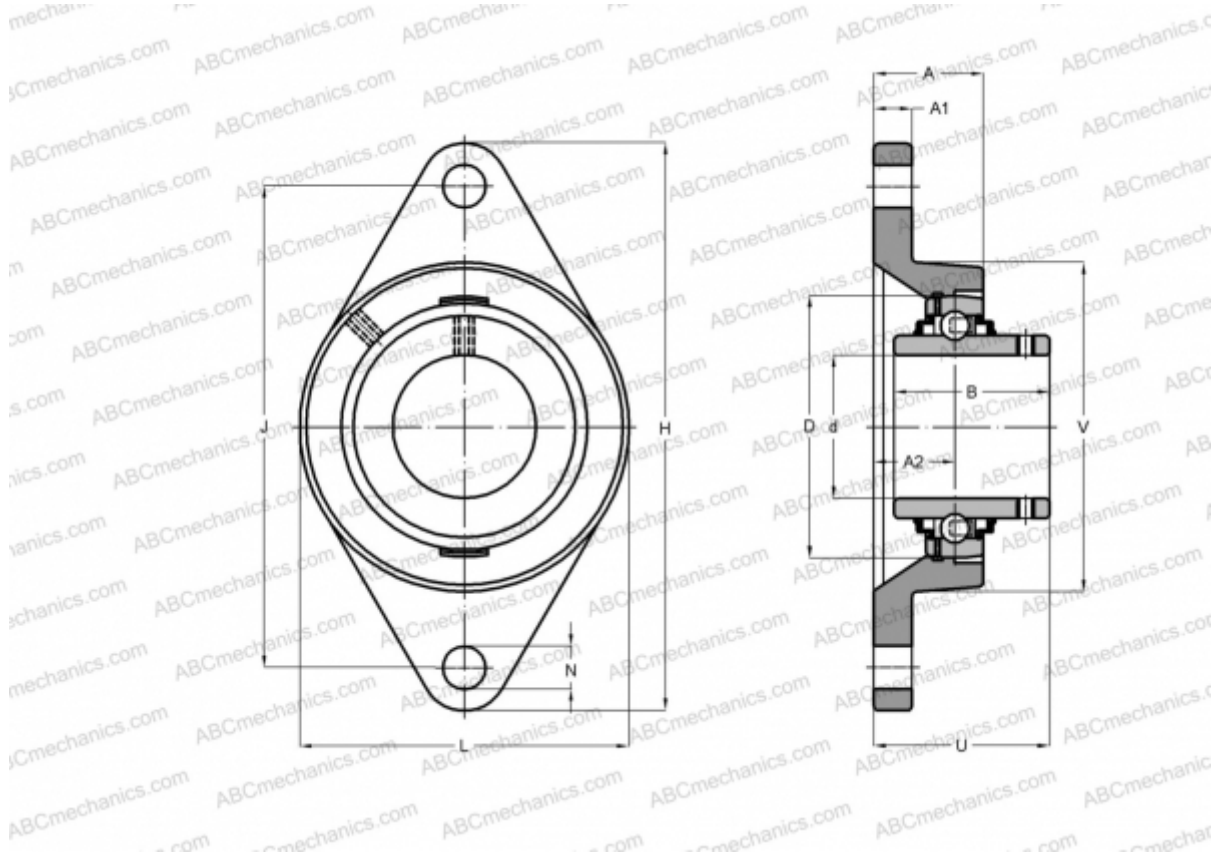

Technical specification

DIMENSIONS, MM

d	35,000
D	72,000
B	42,900
L	90,000
H	161,000
A	34,000
J	130,000
A1	16,000
A2	17,500
N	16,000
U	44,400

WEIGHT, KG

	1,200
Bearing	UC 207

Housing

FL 207

MANUFACTURER

[ASAHI](#)