

UCFL 306 ASAHI

Ball bearing units

TYPE: Housing units, Two-bolt flanged housing units, Cast iron housing, Radial insert ball bearing with grub screws in inner ring, Type UCFL (ASAHI)

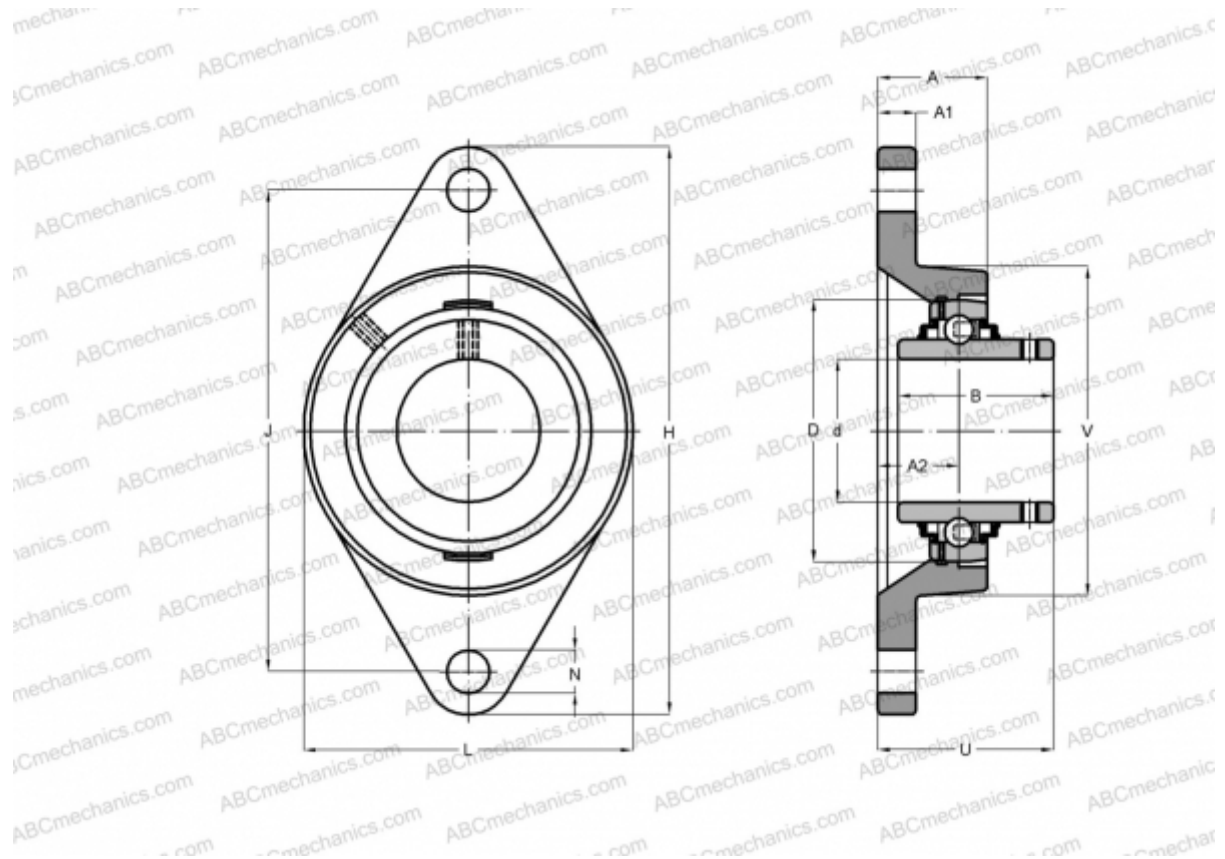

Technical specification

DIMENSIONS, MM

d	30,000
D	72,000
B	43,000
L	90,000
H	180,000
A	32,000
J	134,000
A1	15,000
A2	17,000
N	23,000
U	44,000

WEIGHT, KG

	1,500
Bearing	UC 306

Housing

FL 306

MANUFACTURER

[ASAHI](#)