

UCFL 311 ASAHI

Ball bearing units

TYPE: Housing units, Two-bolt flanged housing units, Cast iron housing, Radial insert ball bearing with grub screws in inner ring, Type UCFL (ASAHI)

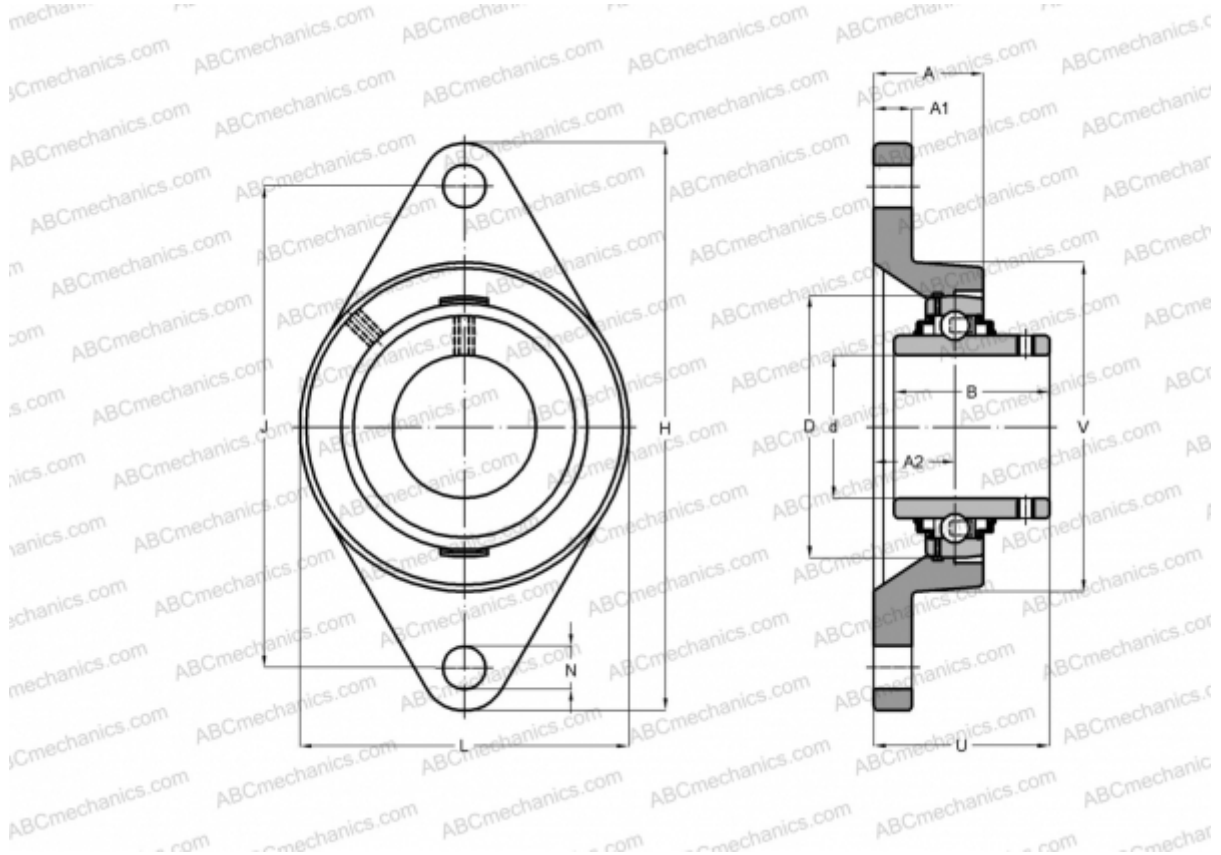

Technical specification

DIMENSIONS, MM

d	55,000
D	120,000
B	66,000
L	150,000
H	250,000
A	52,000
J	198,000
A1	20,000
A2	25,000
N	25,000
U	71,000

WEIGHT, KG

	5,100
Bearing	UC 311

Housing

FL 311

MANUFACTURER

[ASAHI](#)