

## UCFT 208 ASAHI

Ball bearing units

TYPE: Housing units, Two-bolt flanged housing units, Cast iron housing, Radial insert ball bearing with grub screws in inner ring, Type UCFT (ASAHI)

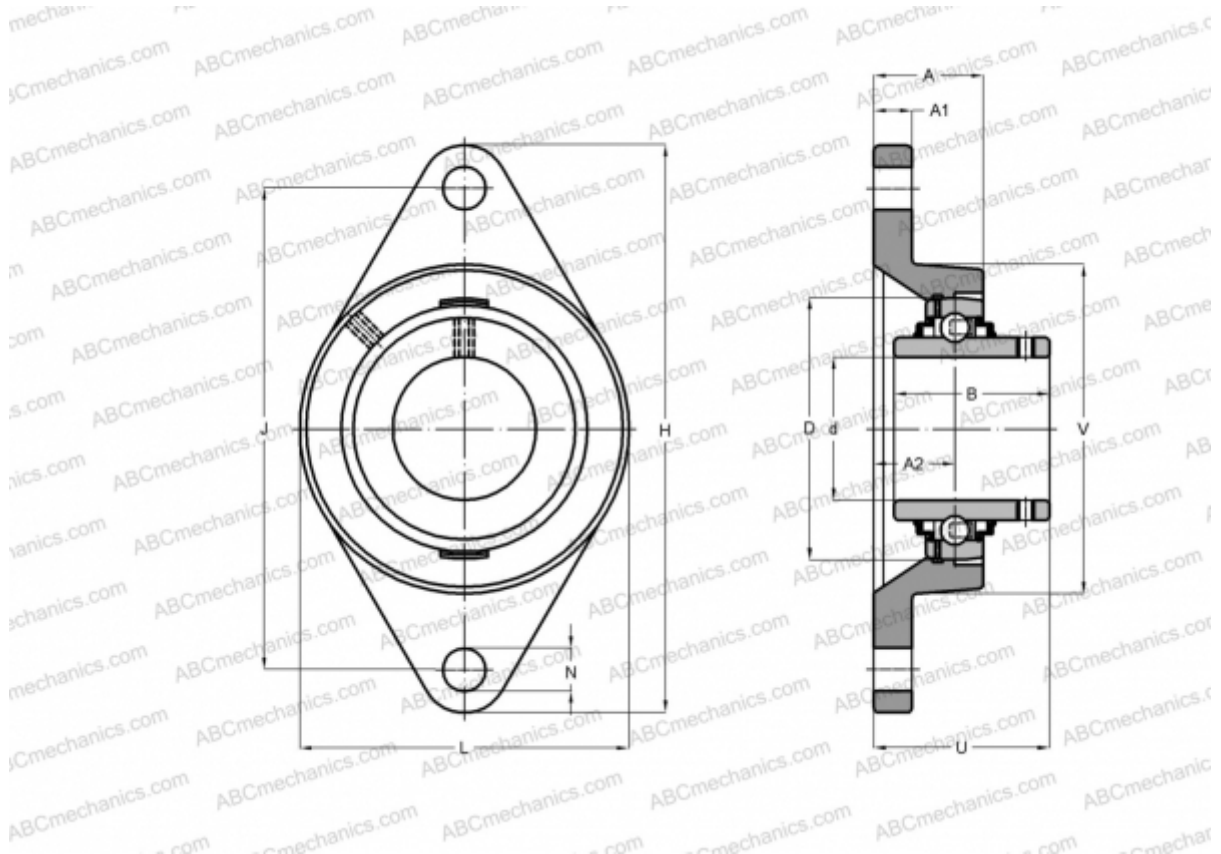

### Technical specification

#### DIMENSIONS, MM

d	40,000
D	80,000
B	49,200
L	105,000
H	171,000
A	38,000
J	143,700
A1	14,000
A2	19,000
N	14,000
U	51,200

#### WEIGHT, KG

	1,800
Bearing	UC 208

Housing

FT 208

**MANUFACTURER**

[ASAHI](#)