

UCFT 210 ASAHI

Ball bearing units

TYPE: Housing units, Two-bolt flanged housing units, Cast iron housing, Radial insert ball bearing with grub screws in inner ring, Type UCFT (ASAHI)

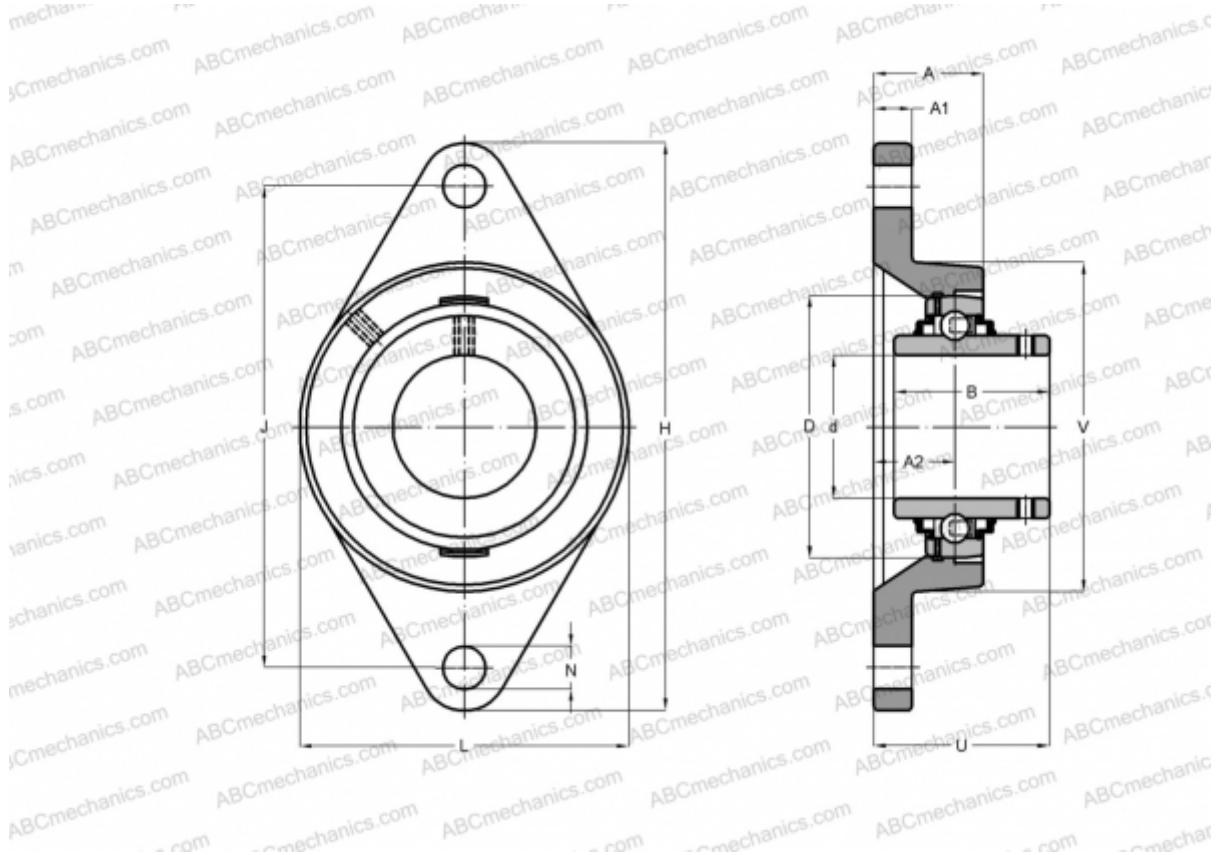

Technical specification

DIMENSIONS, MM

d	50,000
D	90,000
B	51,600
L	116,000
H	189,000
A	40,000
J	157,200
A1	14,000
A2	19,000
N	16,000
U	54,800

WEIGHT, KG

	2,100
Bearing	UC 210

Housing

FT 210

MANUFACTURER

[ASAHI](#)