

UCFL X05 ASAHI

Ball bearing units

TYPE: Housing units, Two-bolt flanged housing units, Cast iron housing, Radial insert ball bearing with grub screws in inner ring, Type UCFLX (ASAHI)

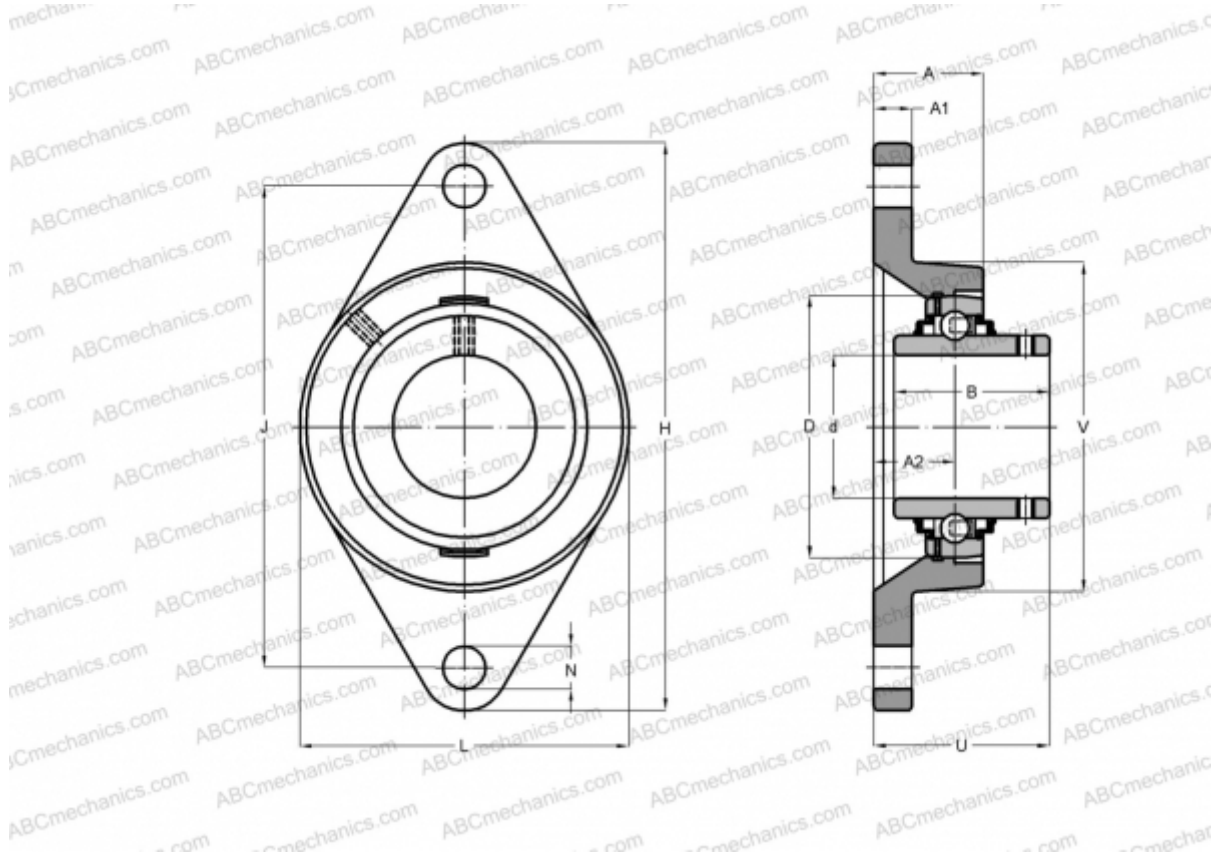

Technical specification

DIMENSIONS, MM

d	25,000
D	62,000
B	38,100
L	83,000
H	141,000
A	30,000
J	117,000
A1	13,000
A2	15,900
N	12,000
U	40,200

WEIGHT, KG

	1,000
Bearing	UC X05

Housing

FL X05

MANUFACTURER

[ASAHI](#)

REPLACES

UCFLX05