

UCFL X06 ASAHI

Ball bearing units

TYPE: Housing units, Two-bolt flanged housing units, Cast iron housing, Radial insert ball bearing with grub screws in inner ring, Type UCFLX (ASAHI)

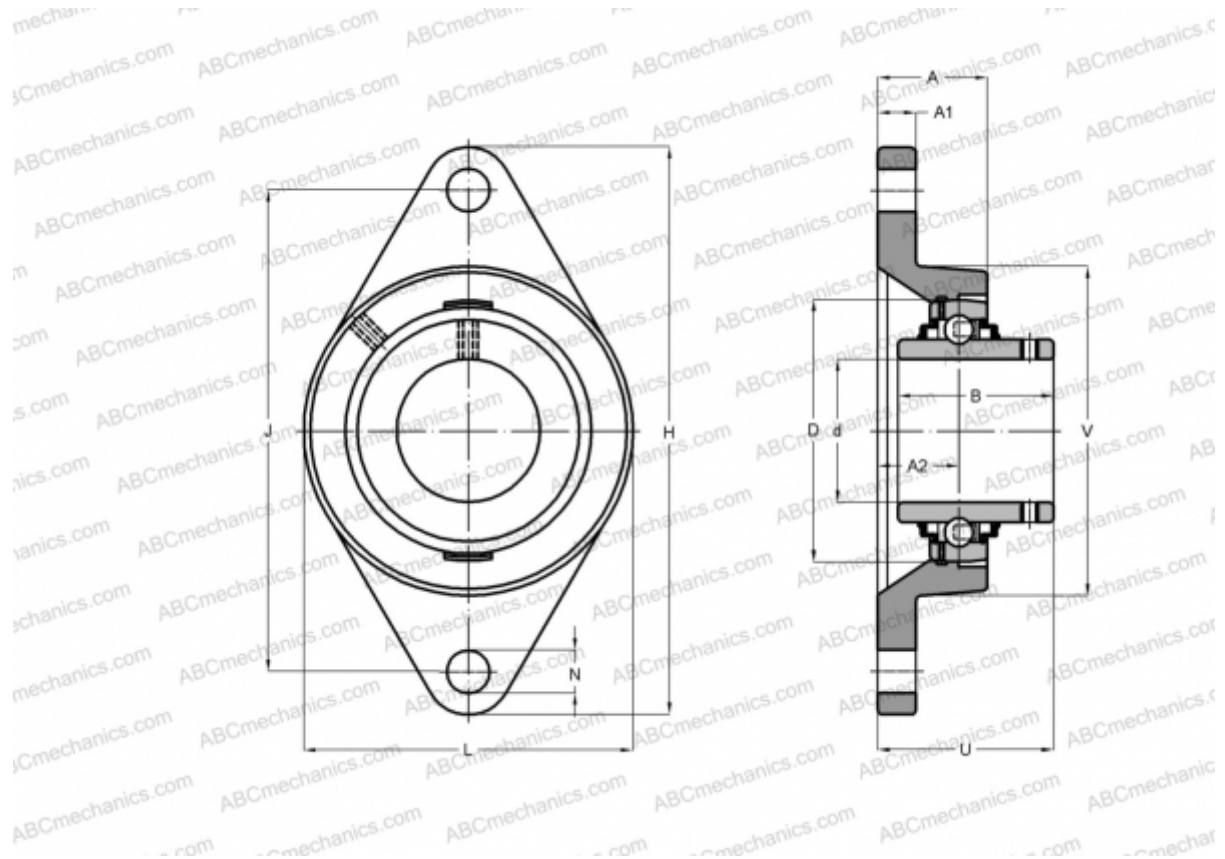

Technical specification

DIMENSIONS, MM

d	30,000
D	72,000
B	42,900
L	95,000
H	156,000
A	34,000
J	130,000
A1	14,000
A2	17,500
N	16,000
U	44,400

WEIGHT, KG

	1,400
Bearing	UC X06

Housing

FL X06

MANUFACTURER

[ASAHI](#)

REPLACES

UCFLX06