

UCFL X10 ASAHI

Ball bearing units

TYPE: Housing units, Two-bolt flanged housing units, Cast iron housing, Radial insert ball bearing with grub screws in inner ring, Type UCFLX (ASAHI)

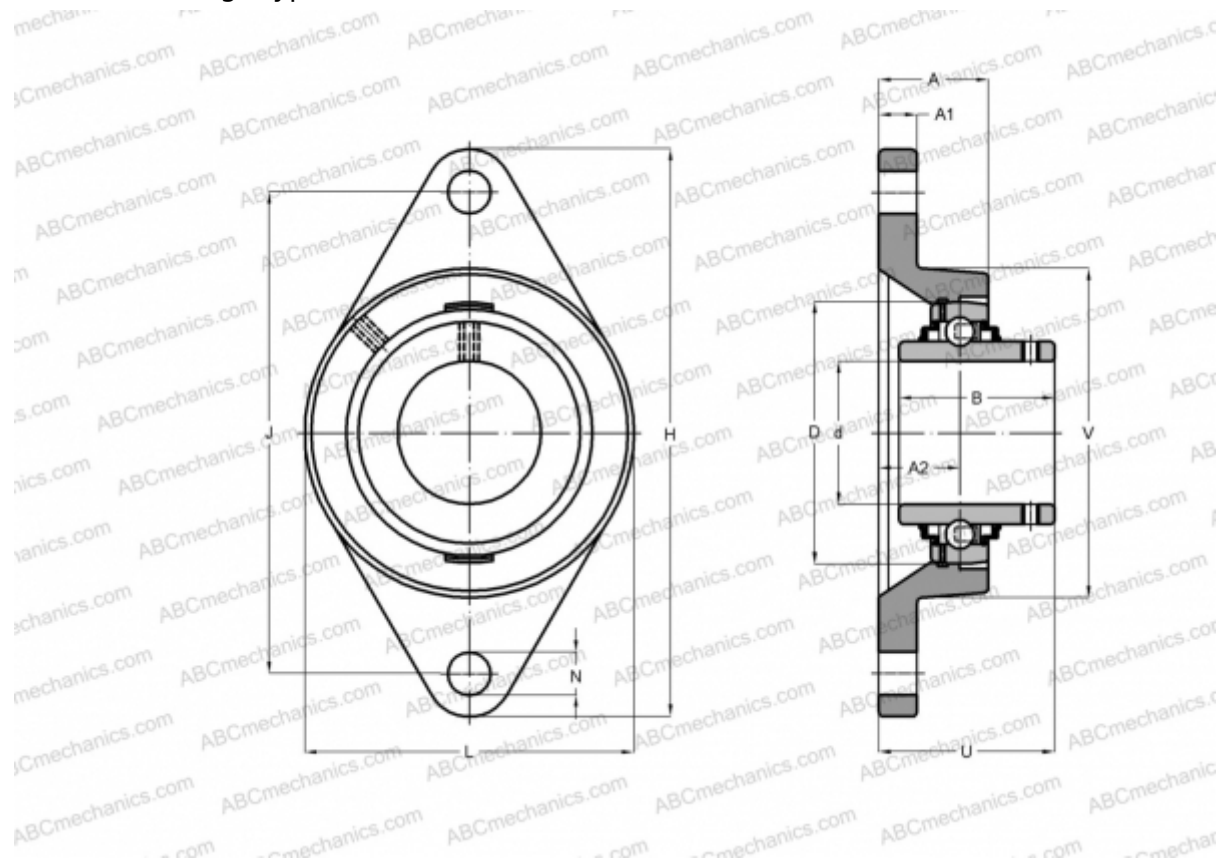

Technical specification

DIMENSIONS, MM

d	50,000
D	100,000
B	55,600
L	133,000
H	216,000
A	44,000
J	184,000
A1	20,000
A2	22,200
N	19,000
U	59,400

WEIGHT, KG 3,600

Bearing UC X10

Housing

FL X10

MANUFACTURER

[ASAHI](#)

REPLACES

UCFLX10