

BLFL 2J ASAHI

Ball bearing units

TYPE: Housing units, Two-bolt flanged housing units, Cast iron housing, Radial insert ball bearing with grub screws in inner ring, Type BLFL (ASAHI)

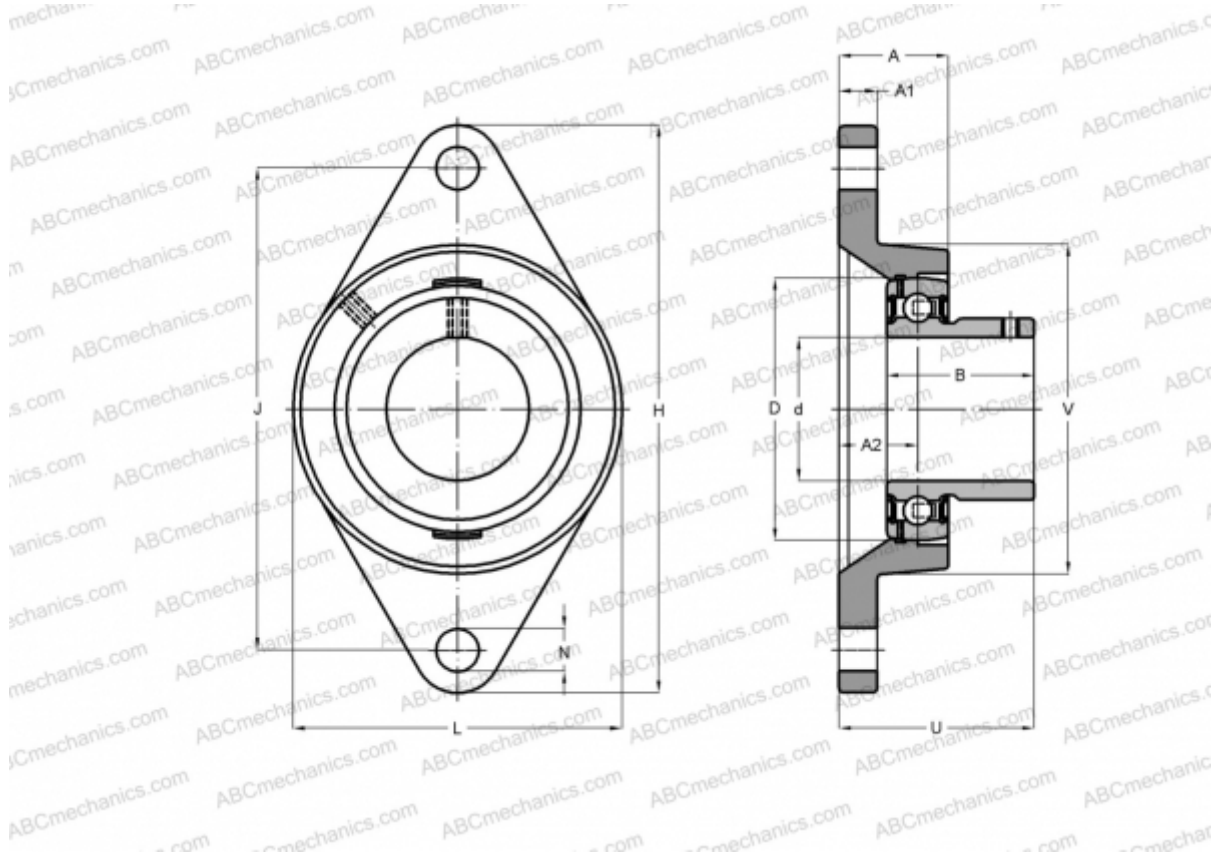

Technical specification

DIMENSIONS, MM

d	15,000
D	40,000
B	22,000
L	56,000
H	81,000
A	18,000
J	63,500
A1	9,500
A2	9,500
N	7,000
U	25,500

WEIGHT, KG

Bearing 0,270

Housing

MANUFACTURER

LFL 3J

[ASAHI](#)