

BLFL 5J ASAHI

Ball bearing units

TYPE: Housing units, Two-bolt flanged housing units, Cast iron housing, Radial insert ball bearing with grub screws in inner ring, Type BLFL (ASAHI)

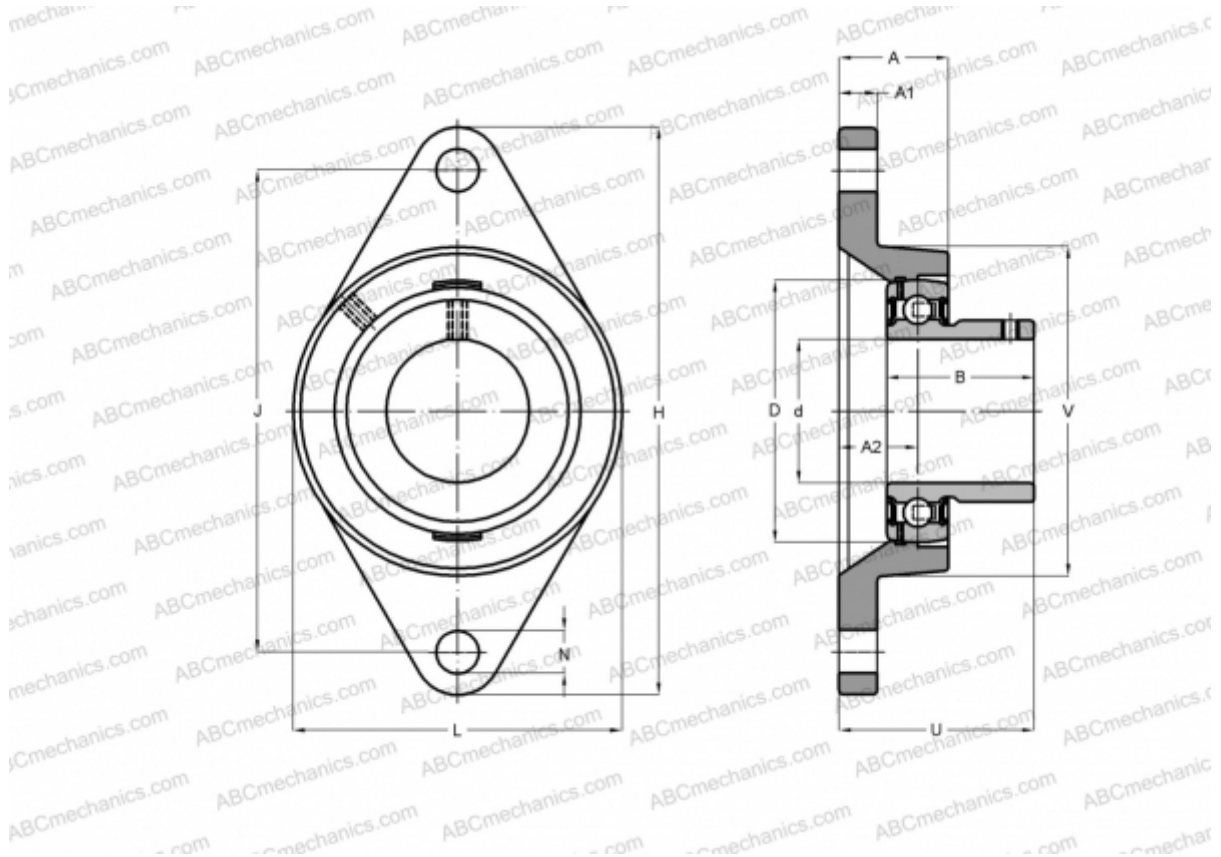

Technical specification

DIMENSIONS, MM

d	25,000
D	52,000
B	27,000
L	69,000
H	95,000
A	20,000
J	76,000
A1	11,000
A2	11,000
N	10,000
U	30,500

WEIGHT, KG

0,400

Bearing

B 5

Housing

LFL 5J

MANUFACTURER

[ASAHI](#)