

BLCTE 202K ASAHI

Ball bearing units

TYPE: Housing units, Two-bolt flanged housing units, Cast iron housing, Radial insert ball bearing with grub screws in inner ring, Type BLCTE (ASAHI)

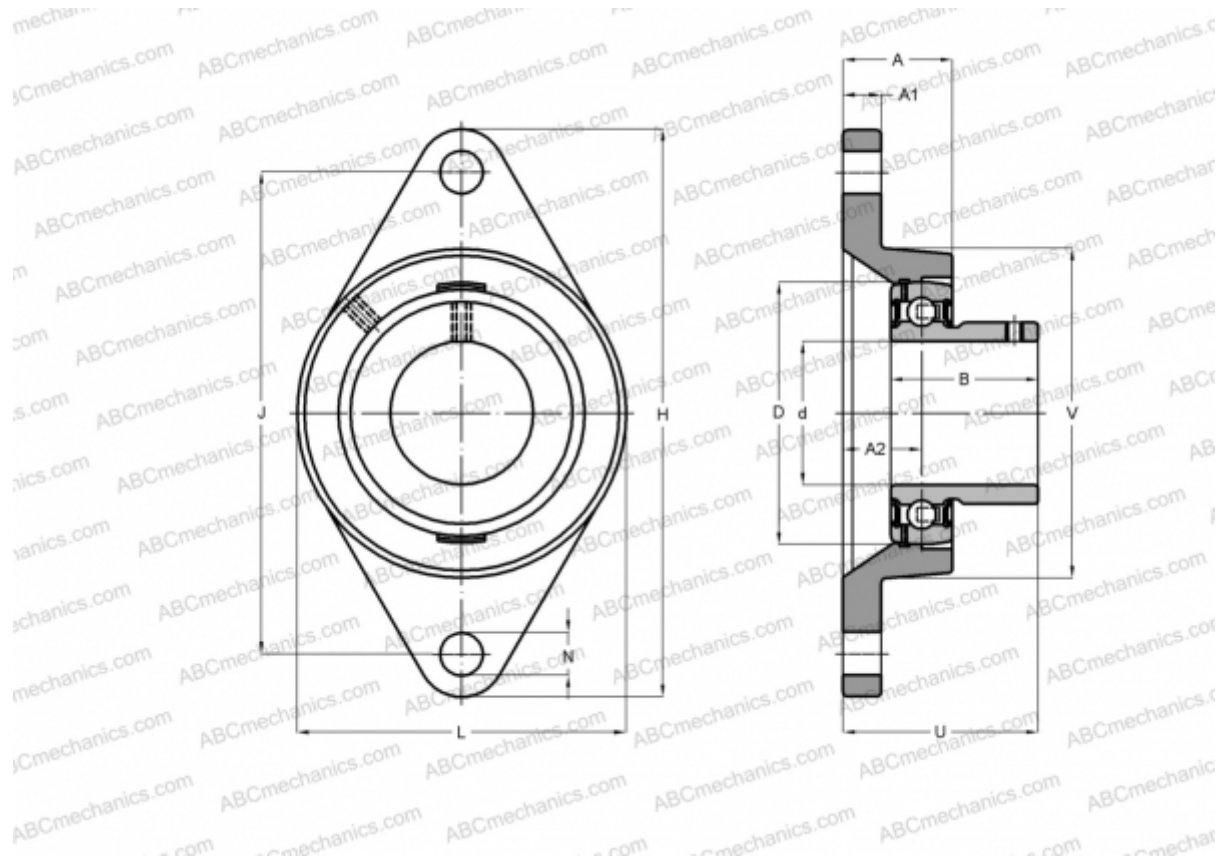

Technical specification

DIMENSIONS, MM

d	15,000
D	40,000
B	22,000
L	59,000
H	81,000
A	15,000
J	63,500
A2	8,500
N	7,000
U	24,500

MANUFACTURER

[ASAHI](#)

WEIGHT, KG

0,220

Bearing	B 2
Housing	LCTE 203K