

BLCTE 204K ASAHI

Ball bearing units

TYPE: Housing units, Two-bolt flanged housing units, Cast iron housing, Radial insert ball bearing with grub screws in inner ring, Type BLCTE (ASAHI)

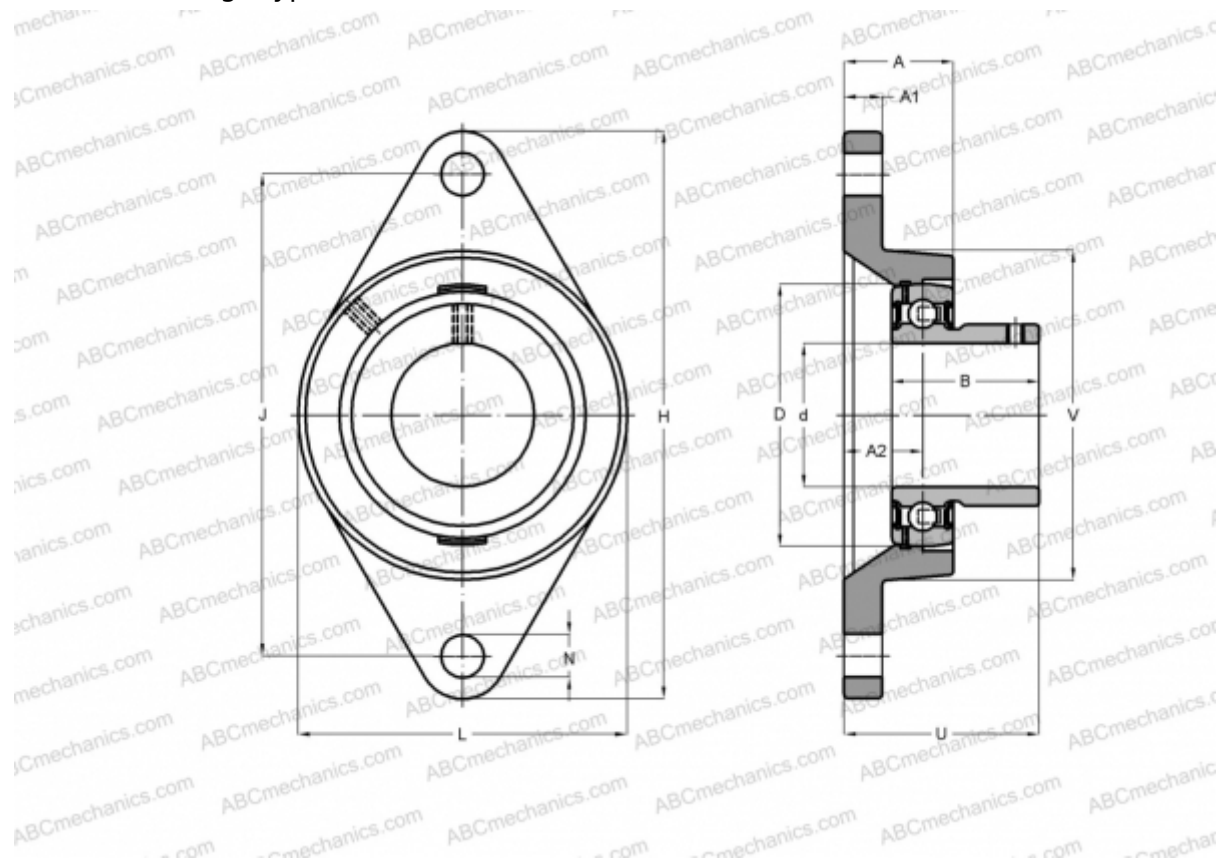

Technical specification

DIMENSIONS, MM

d	20,000
D	47,000
B	24,700
L	67,000
H	90,000
A	17,000
J	71,400
A2	9,500
N	10,000
U	27,200

MANUFACTURER

[ASAHI](#)

WEIGHT, KG

0,400

Bearing	B 4
Housing	LCTE 204K