

UKP 212 + H2312 ASAHI

Ball bearing units

TYPE: Housing units, Plummer block, Cast iron housing, Radial insert ball bearing with adapter sleeve, Type UKP (ASAHI)

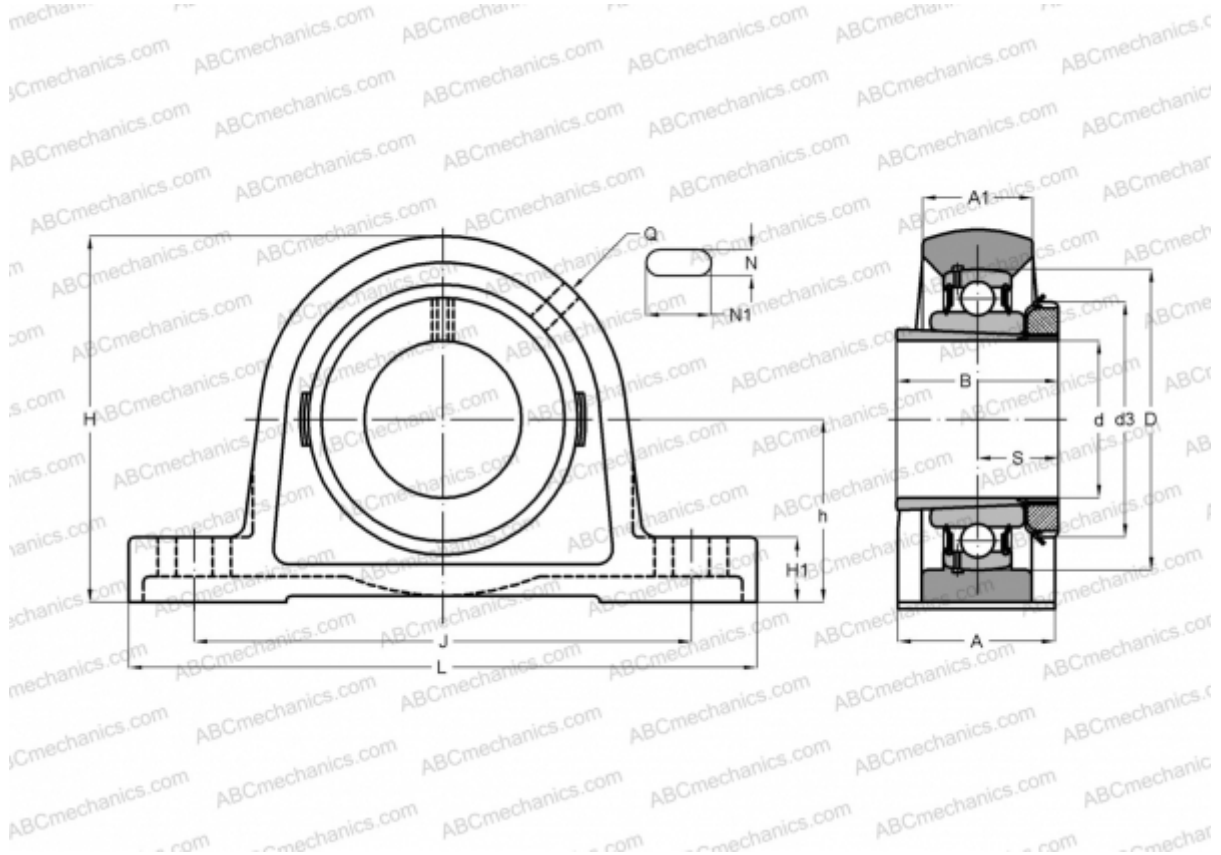

Technical specification

DIMENSIONS, MM

d	55,000
D	110,000
B	62,000
L	241,000
H	138,000
A	70,000
J	184,000
H1	25,000
N	20,000
N1	25,000
d3	80,000
h	69,800

WEIGHT, KG

4,800

Bearing	UK 212
Housing	P 212
Adapter sleeve	H2312

MANUFACTURER

[ASAHI](#)