

UKP 216 + H2316 ASAHI

Ball bearing units

TYPE: Housing units, Plummer block, Cast iron housing, Radial insert ball bearing with adapter sleeve, Type UKP (ASAHI)

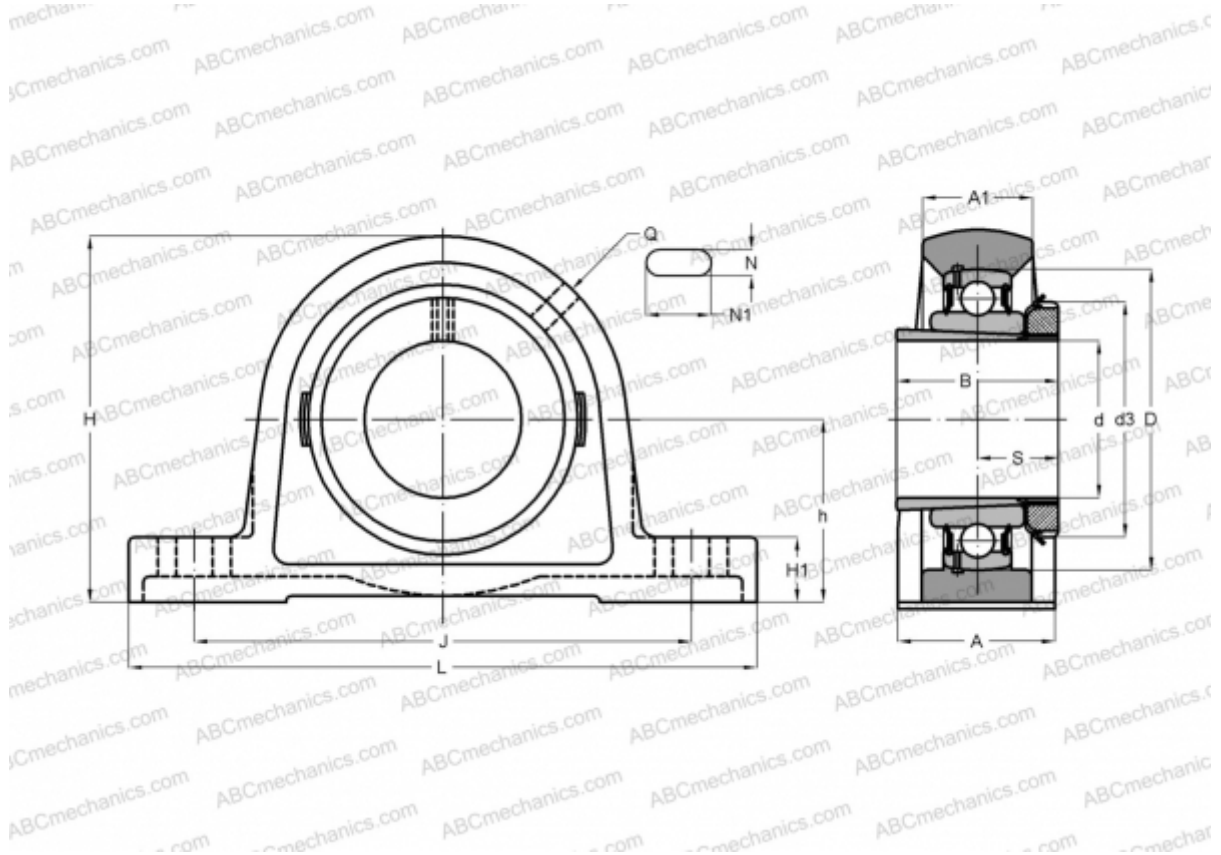

Technical specification

DIMENSIONS, MM

d	70,000
D	140,000
B	78,000
L	292,000
H	175,000
A	78,000
J	232,000
H1	30,000
N	25,000
N1	31,000
d3	105,000
h	88,900

WEIGHT, KG

10,400

Bearing	UK 216
Housing	P 216
Adapter sleeve	H2316

MANUFACTURER

[ASAHI](#)