

UKP 218 + H2318 ASAHI

Ball bearing units

TYPE: Housing units, Plummer block, Cast iron housing, Radial insert ball bearing with adapter sleeve, Type UKP (ASAHI)

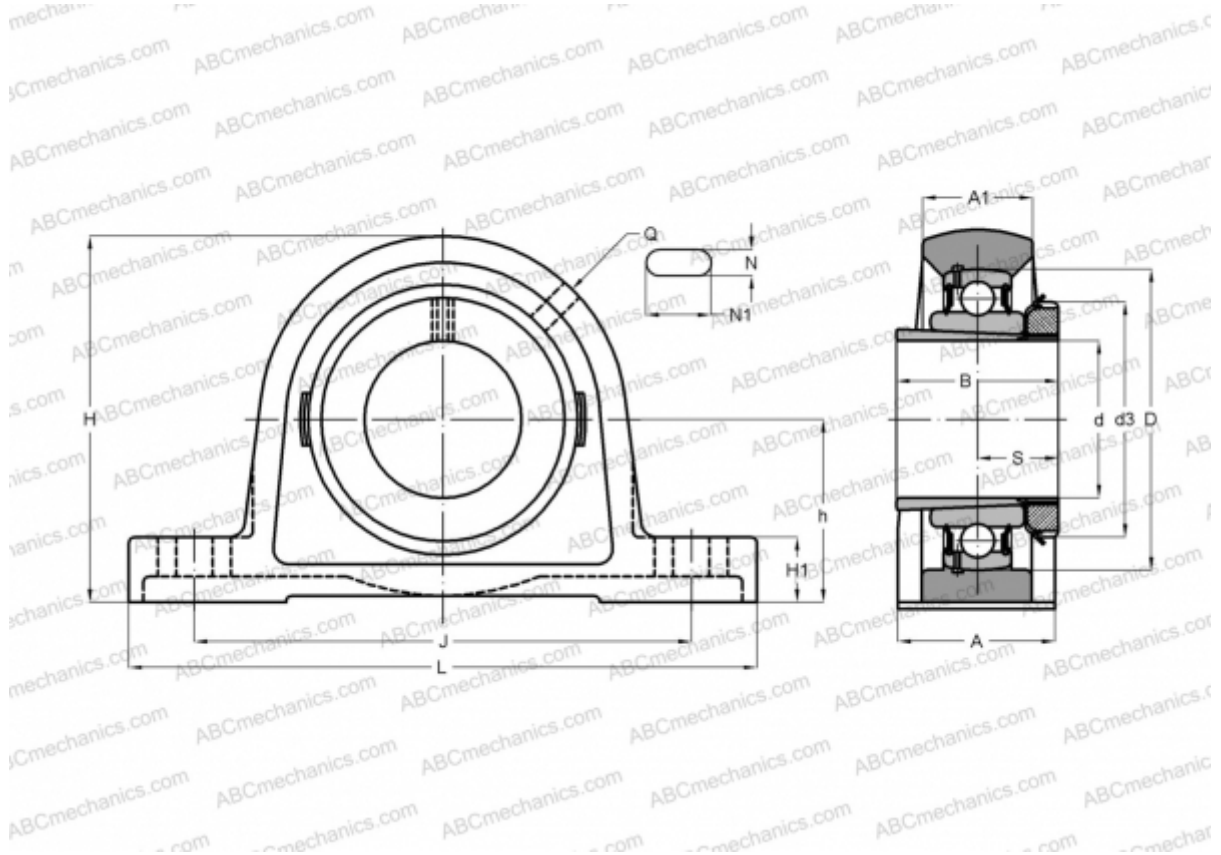

Technical specification

DIMENSIONS, MM

d	80,000
D	160,000
B	86,000
L	327,000
H	200,000
A	88,000
J	262,000
H1	34,000
N	27,000
N1	33,000
d3	120,000
h	101,600

WEIGHT, KG

15,100

Bearing	UK 218
Housing	P 218
Adapter sleeve	H2318

MANUFACTURER

[ASAHI](#)