

UKP 307 + H2307 ASAHI

Ball bearing units

TYPE: Housing units, Plummer block, Cast iron housing, Radial insert ball bearing with adapter sleeve, Type UKP (ASAHI)

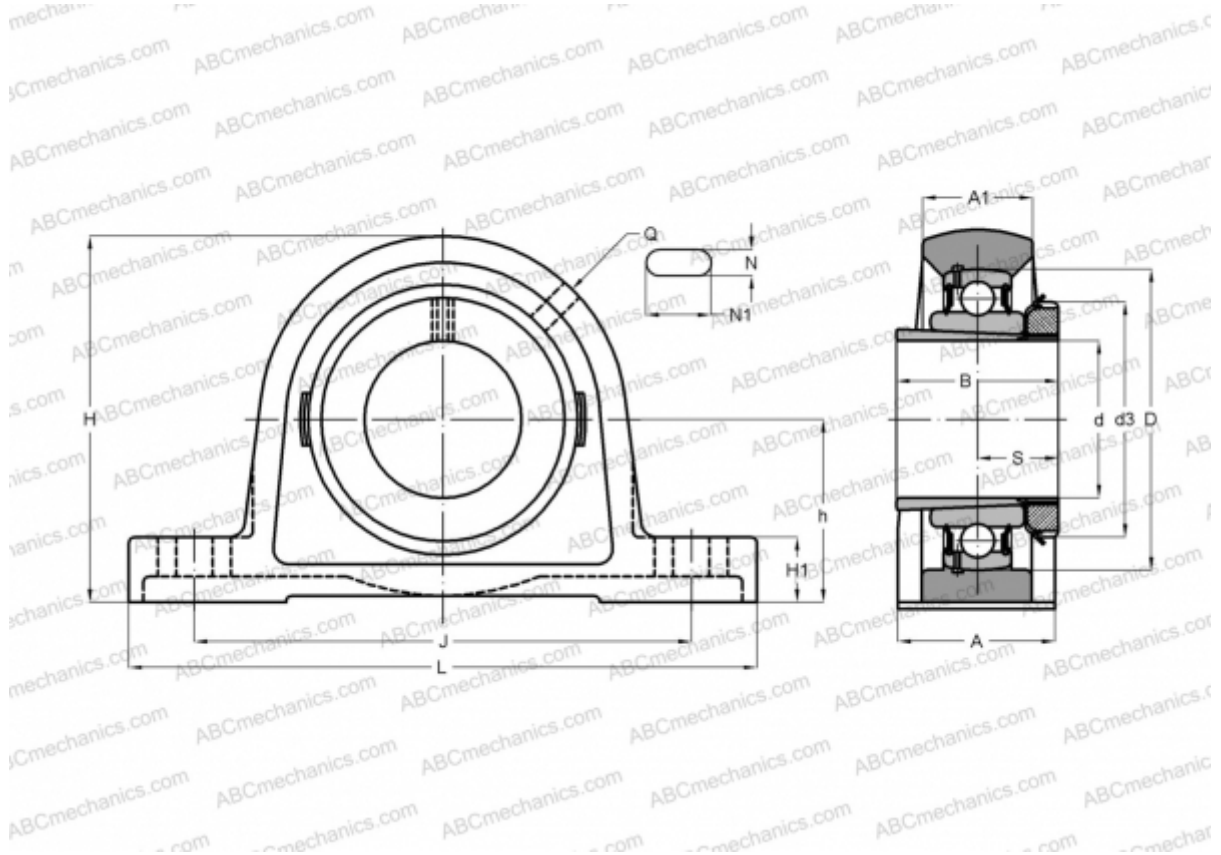

Technical specification

DIMENSIONS, MM

d	30,000
D	80,000
B	43,000
L	210,000
H	105,000
A	56,000
J	160,000
H1	21,000
N	17,000
N1	25,000
d3	52,000
h	56,000

WEIGHT, KG 2,700

Bearing	UK 307
Housing	P 307
Adapter sleeve	H2307

MANUFACTURER

[ASAHI](#)