

UKP 312 + H2312 ASAHI

Ball bearing units

TYPE: Housing units, Plummer block, Cast iron housing, Radial insert ball bearing with adapter sleeve, Type UKP (ASAHI)

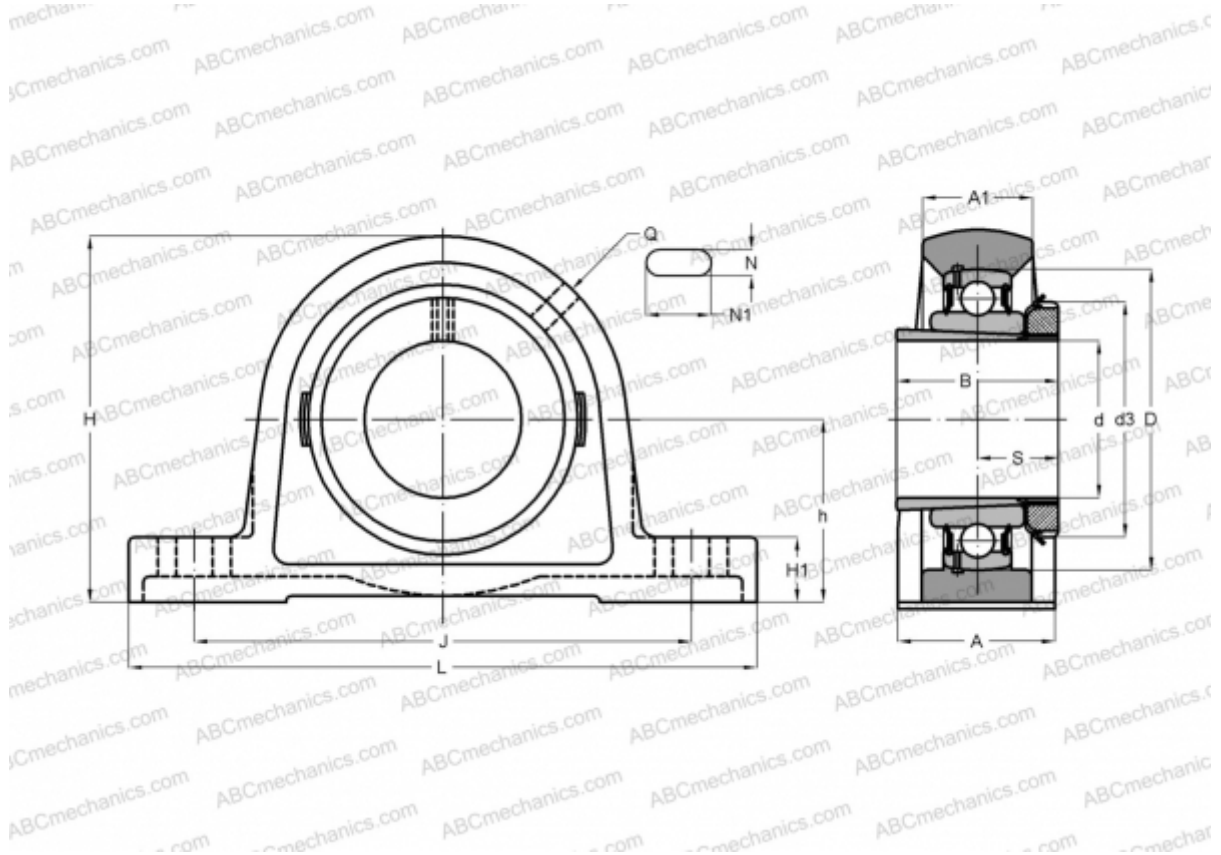

Technical specification

DIMENSIONS, MM

d	55,000
D	130,000
B	62,000
L	330,000
H	165,000
A	85,000
J	250,000
H1	33,000
N	25,000
N1	38,000
d3	80,000
h	85,000

WEIGHT, KG

9,300

Bearing	UK 312
Housing	P 312
Adapter sleeve	H2312

MANUFACTURER

[ASAHI](#)