

UKP X06 + H2306 ASAHI

Ball bearing units

TYPE: Housing units, Plummer block, Cast iron housing, Radial insert ball bearing with adapter sleeve, Type UKPX (ASAHI)

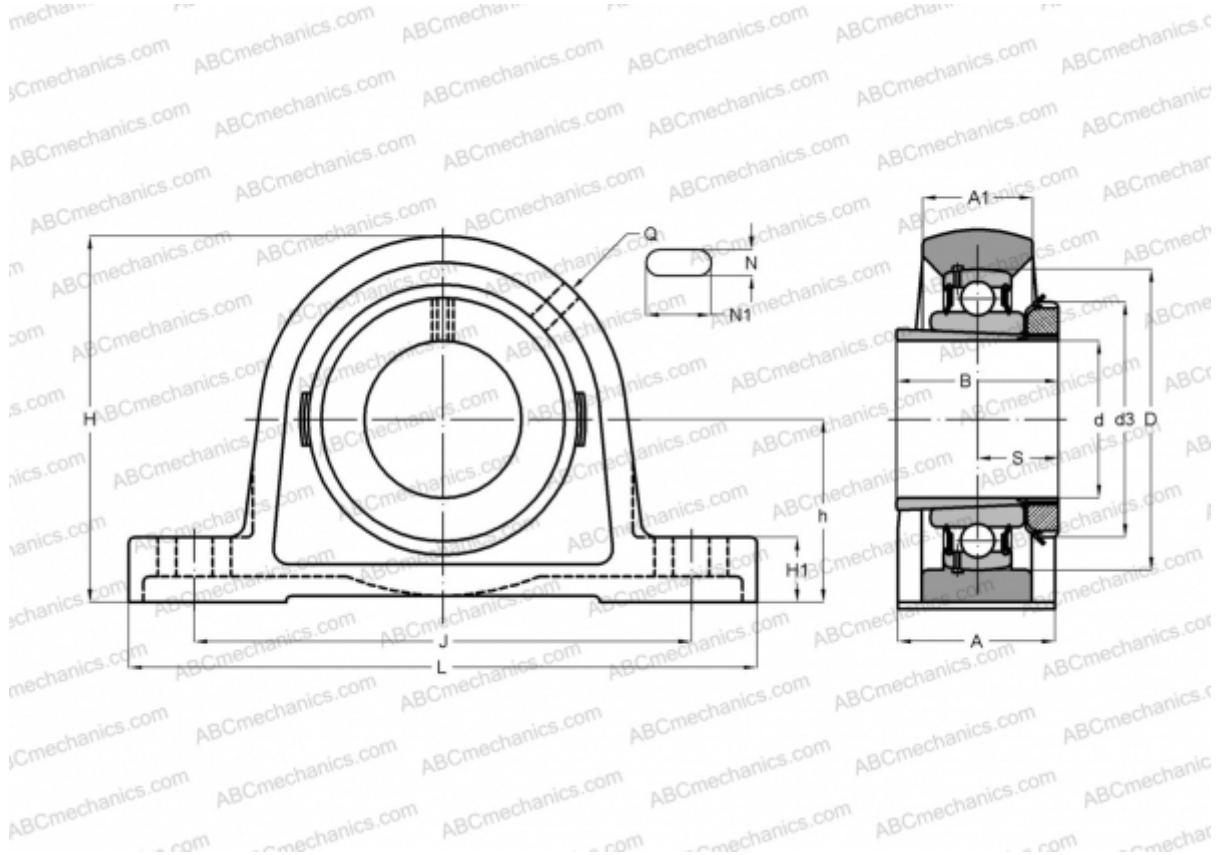

Technical specification

DIMENSIONS, MM

d	25,000
D	72,000
B	38,000
L	175,000
H	94,000
A	57,000
J	127,000
H1	20,000
N	17,000
N1	25,000
d3	45,000
h	47,600

WEIGHT, KG

2,000

Bearing	UKX06
Housing	PX06
Adapter sleeve	H2306

MANUFACTURER

[ASAHI](#)

REPLACES

UKPX06