

BPP 2 ASAHI

Ball bearing units

TYPE: Housing units, Plummer block, Sheet steel housing, Radial insert ball bearing with grub screws in inner ring, Type BPP (ASAHI)

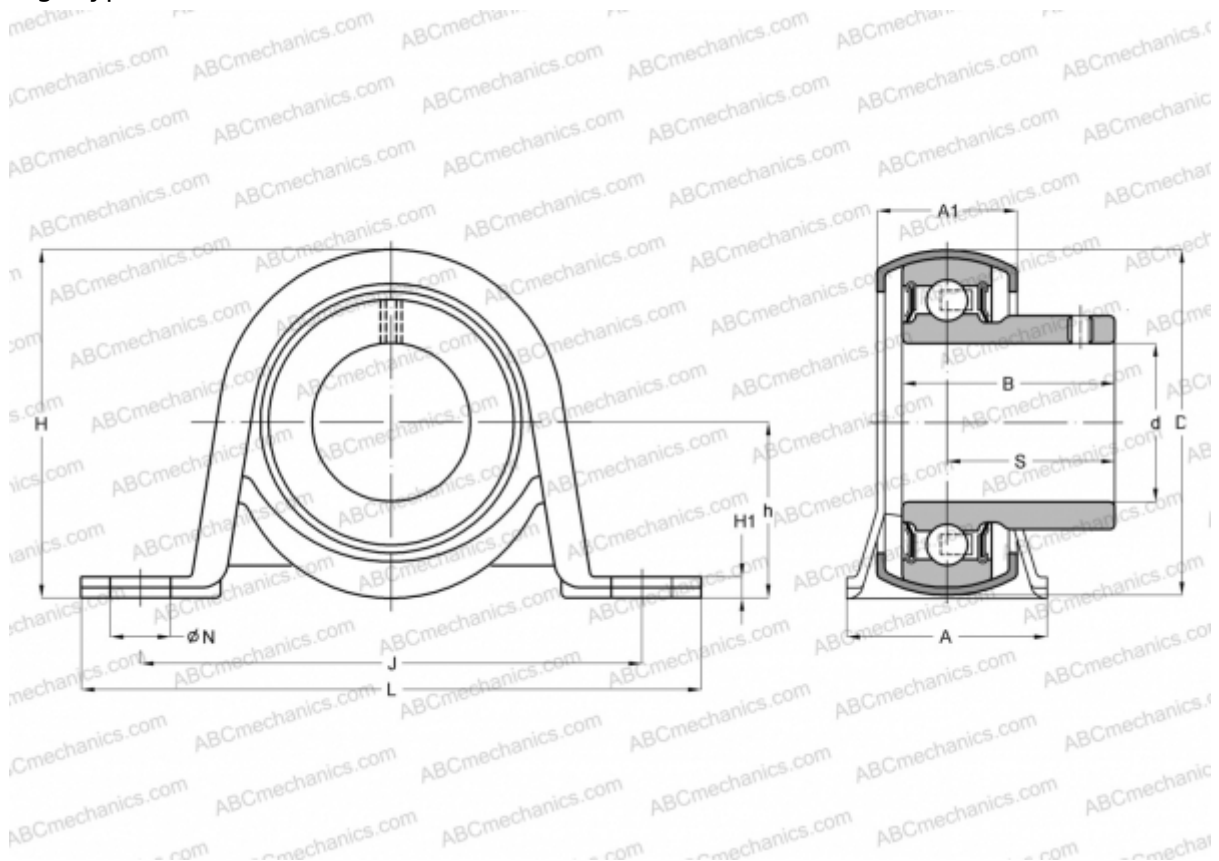

Technical specification

DIMENSIONS, MM

d	15,000
D	40,000
B	22,000
L	86,000
H	44,000
A	25,000
J	68,000
H1	3,200
N	9,500
S	16,000
h	22,200

WEIGHT, KG

	0,150
Bearing	B 2

Housing

PP 3

MANUFACTURER

[ASAHI](#)