

## BPP 6 ASAHI

Ball bearing units

TYPE: Housing units, Plummer block, Sheet steel housing, Radial insert ball bearing with grub screws in inner ring, Type BPP (ASAHI)

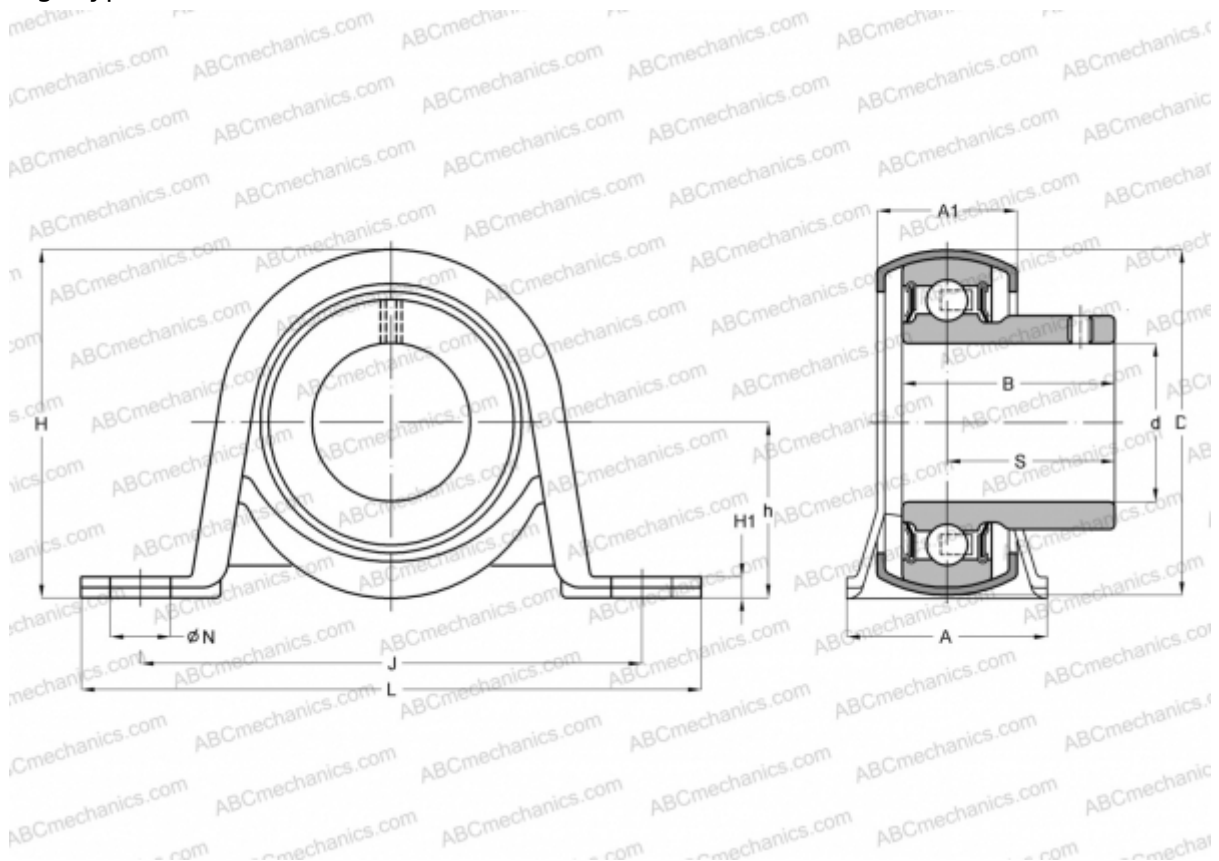

### Technical specification

#### DIMENSIONS, MM

d	30,000
D	62,000
B	30,300
L	117,000
H	66,000
A	38,000
J	95,000
H1	4,000
N	11,500
S	22,300
h	33,300

#### WEIGHT, KG

Bearing

0,420

B 6

Housing

#### MANUFACTURER

PP 6

[ASAHI](#)