

KHPR 202 ASAHI

Ball bearing units

TYPE: Housing units, Plummer block, Sheet steel housing, Radial insert ball bearing with eccentric locking collar and rubber interliner, Type KHPR (ASAHI)

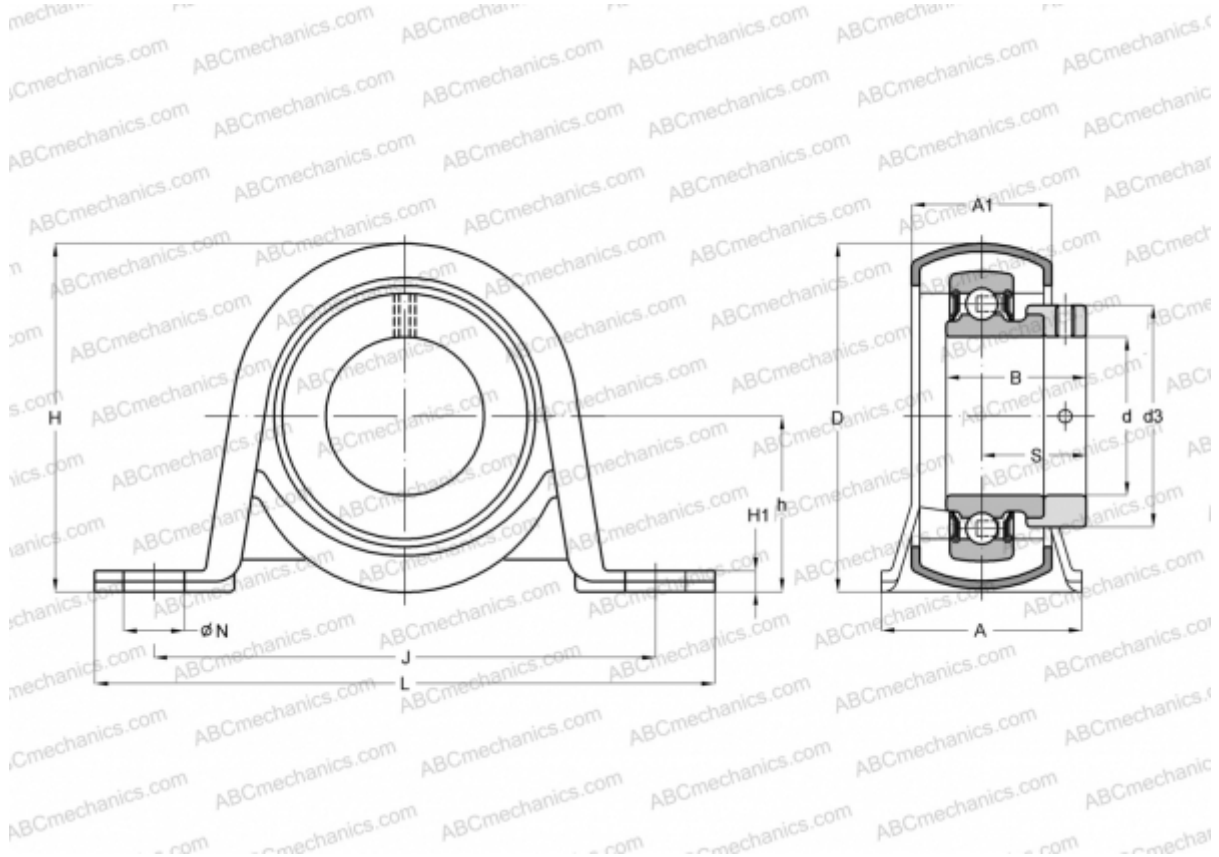

Technical specification

DIMENSIONS, MM

d	15,000
D	40,000
B	28,600
L	98,000
H	50,000
A	32,000
J	76,000
H1	3,200
N	9,500
S	22,100
d3	28,600
h	25,400

WEIGHT, KG

0,200

Bearing

KH 202 AE

Housing

PP 4

Seal

R 4F

MANUFACTURER

[ASAHI](#)