

KHPR 205 ASAHI

Ball bearing units

TYPE: Housing units, Plummer block, Sheet steel housing, Radial insert ball bearing with eccentric locking collar and rubber interliner, Type KHPR (ASAHI)

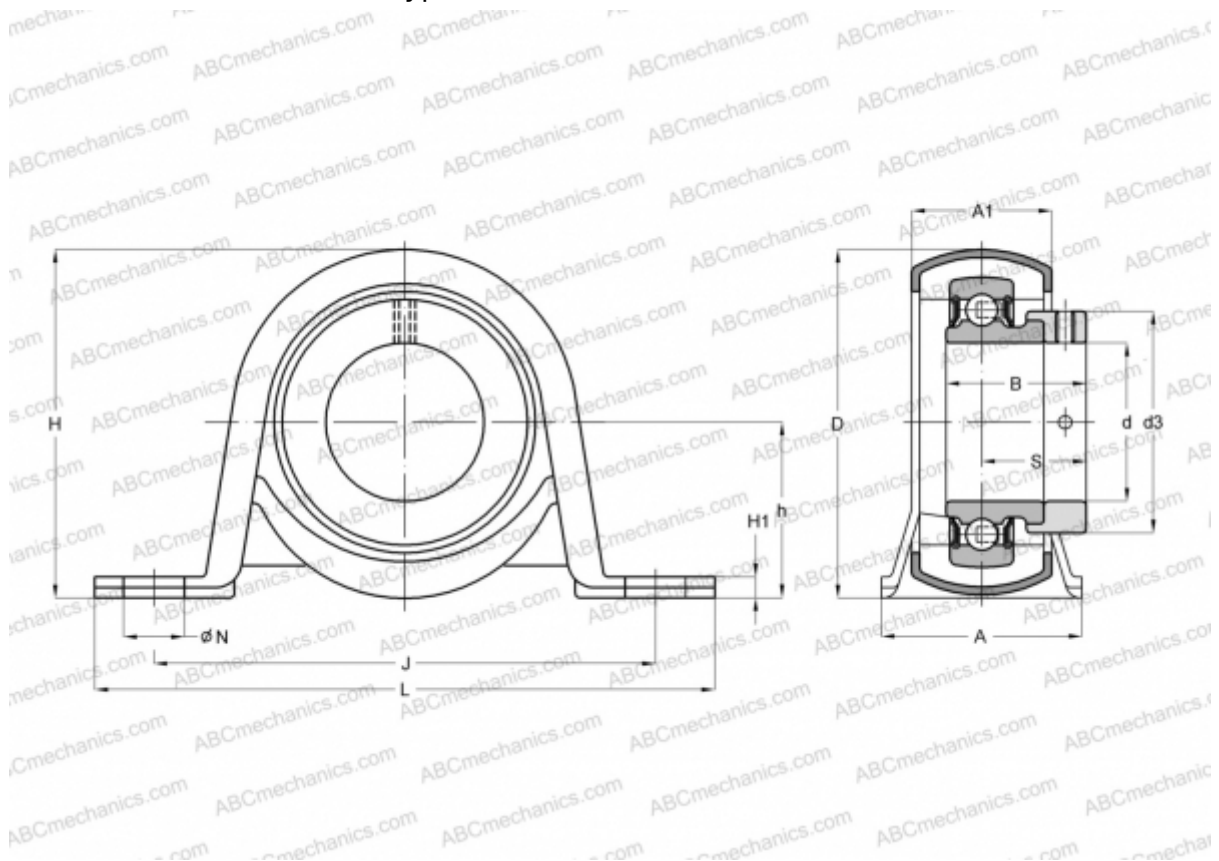

Technical specification

DIMENSIONS, MM

d	25,000
D	52,000
B	31,000
L	117,000
H	66,000
A	38,000
J	95,000
H1	4,000
N	11,500
S	23,500
d3	38,100
h	33,300

WEIGHT, KG

0,350

Bearing	KH 205 AE
Housing	PP 6
Seal	R 6F

MANUFACTURER

[ASAHI](#)