

BPR 1 ASAHI

Ball bearing units

TYPE: Housing units, Plummer block, Sheet steel housing, Radial insert ball bearing with grub screws in inner ring and rubber interliner, Type BPR (ASAHI)

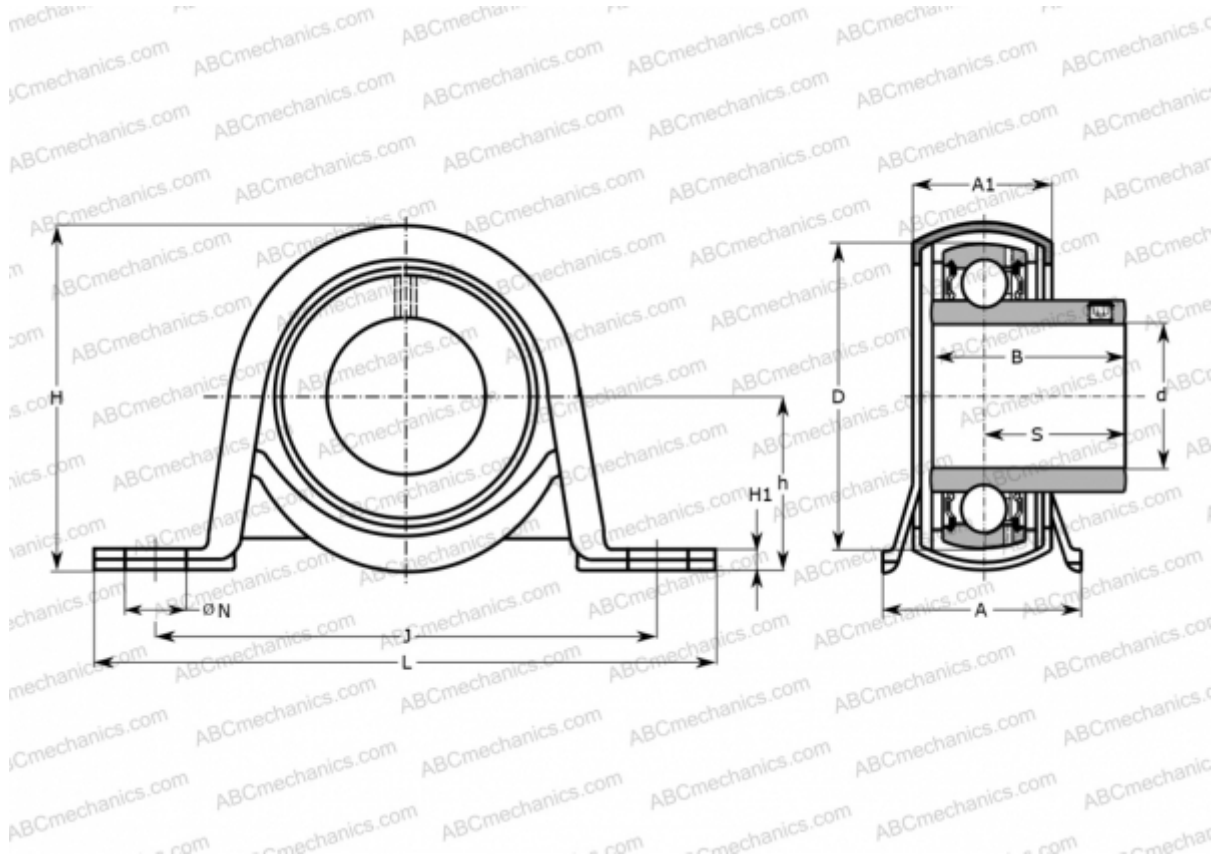

Technical specification

DIMENSIONS, MM

d	12,000
D	40,000
B	22,000
L	98,000
H	50,000
A	32,000
J	76,000
H1	3,200
N	9,500
S	16,000
h	25,400

WEIGHT, KG

0,190

Bearing

B 1

Housing

PP 4

Seal

R 4

MANUFACTURER

[ASAHI](#)