

## BPR 3 ASAHI

Ball bearing units

TYPE: Housing units, Plummer block, Sheet steel housing, Radial insert ball bearing with grub screws in inner ring and rubber interliner, Type BPR (ASAHI)

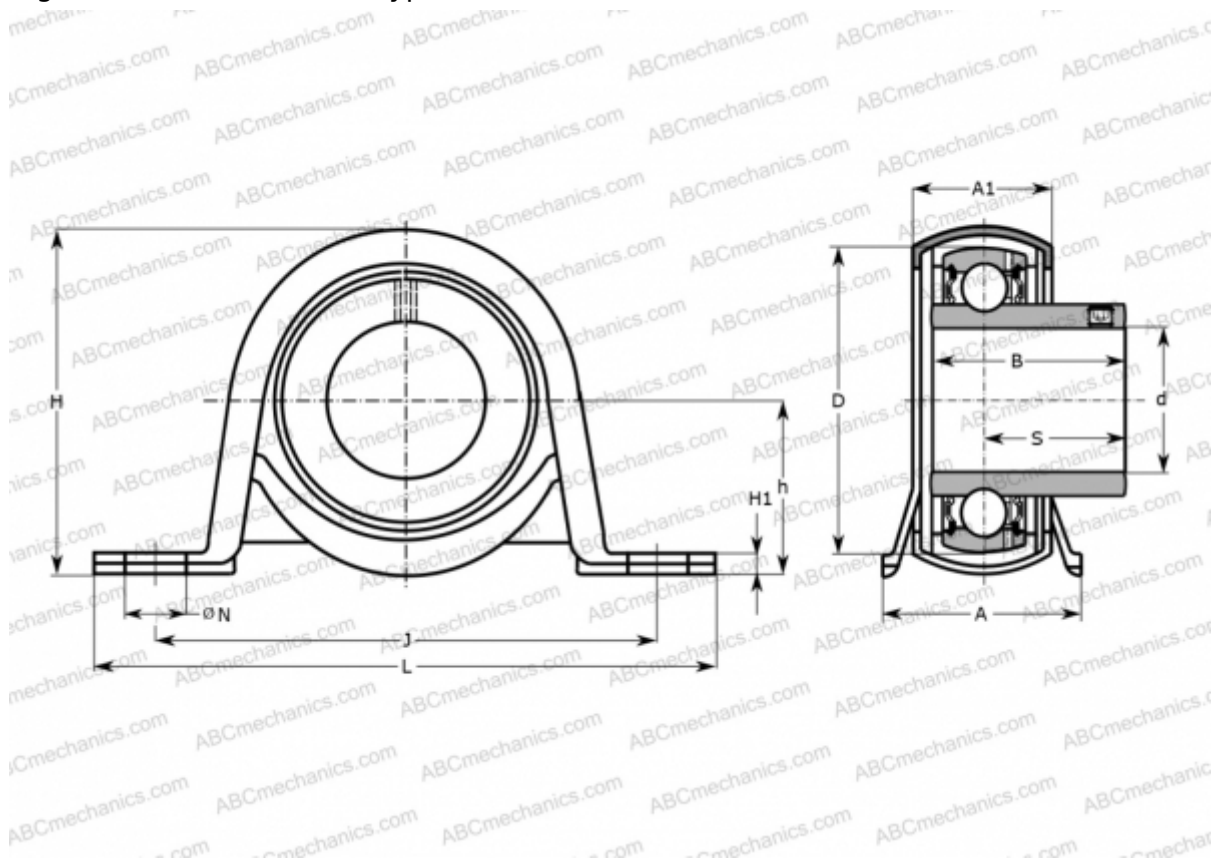

### Technical specification

#### DIMENSIONS, MM

d	17,000
D	40,000
B	22,000
L	98,000
H	50,000
A	32,000
J	76,000
H1	3,200
N	9,500
S	16,000
h	25,400

#### WEIGHT, KG

	0,160
Bearing	B 3

Housing

PP 4

Seal

R 4

#### MANUFACTURER

[ASAHI](#)