

BPR 5 ASAHI

Ball bearing units

TYPE: Housing units, Plummer block, Sheet steel housing, Radial insert ball bearing with grub screws in inner ring and rubber interliner, Type BPR (ASAHI)

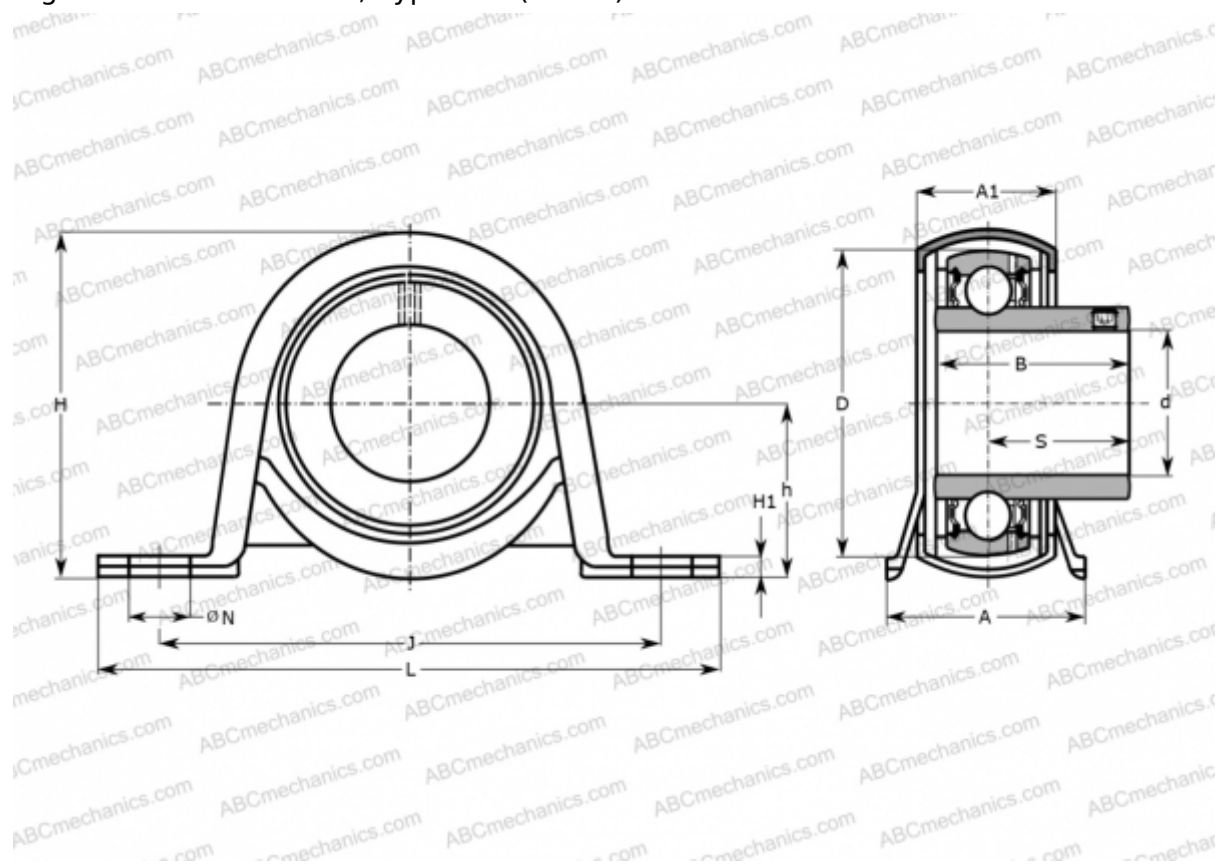

Technical specification

DIMENSIONS, MM

d	25,000
D	52,000
B	27,000
L	117,000
H	66,000
A	38,000
J	95,000
H1	4,000
N	11,500
S	19,500
h	33,300

WEIGHT, KG

	0,330
Bearing	B 5

Housing

PP 6

Seal

R 6

MANUFACTURER

[ASAHI](#)