

BPFL 1 ASAHI

Ball bearing units

TYPE: Housing units, Two-bolt flanged housing units, Sheet steel housing, Radial insert ball bearing with grub screws in inner ring, Type BPFL (ASAHI)

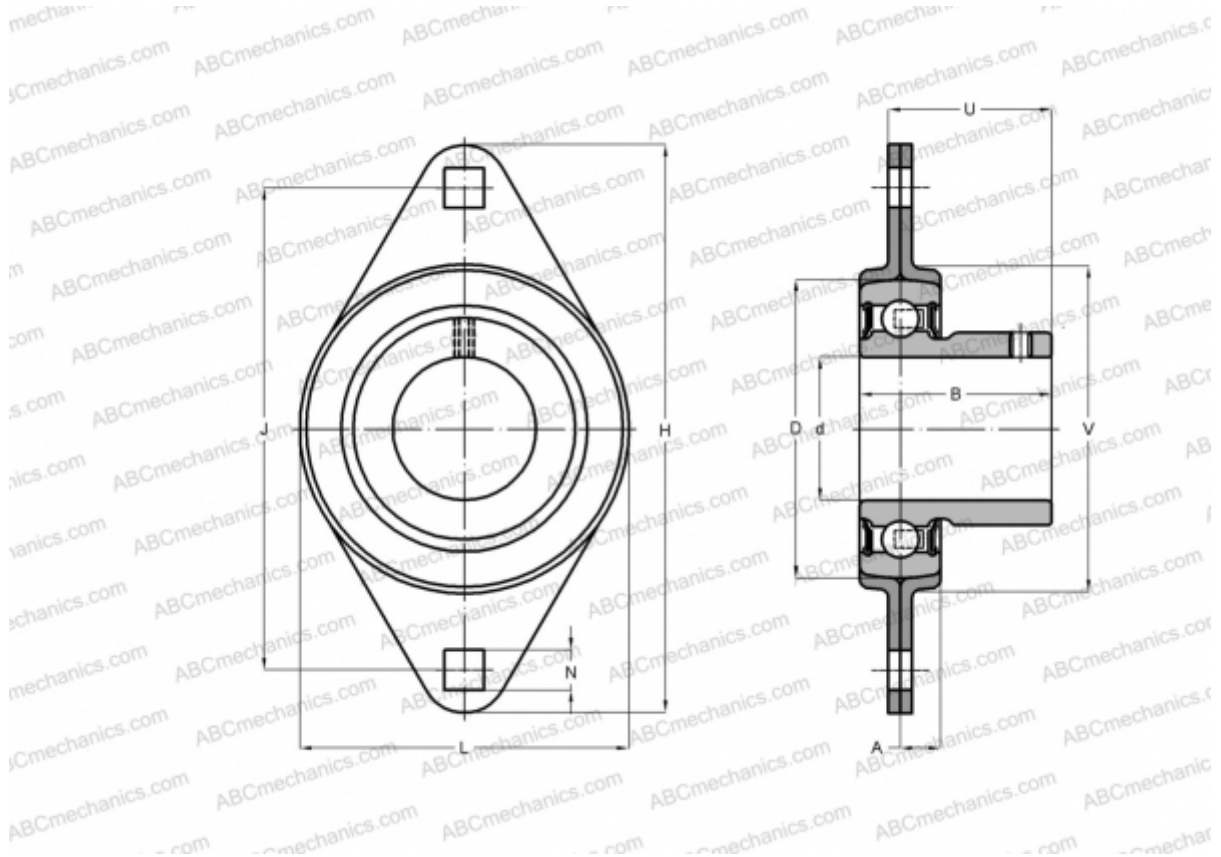

Technical specification

DIMENSIONS, MM

d	12,000
D	40,000
B	22,000
L	59,000
H	81,000
A	7,000
J	63,500
N	7,000
V	49,000

WEIGHT, KG 0,250

Bearing	B 1
Housing	PFL 3

MANUFACTURER

[ASAHI](#)