

## BPFL 3 ASAHI

Ball bearing units

TYPE: Housing units, Two-bolt flanged housing units, Sheet steel housing, Radial insert ball bearing with grub screws in inner ring, Type BPFL (ASAHI)

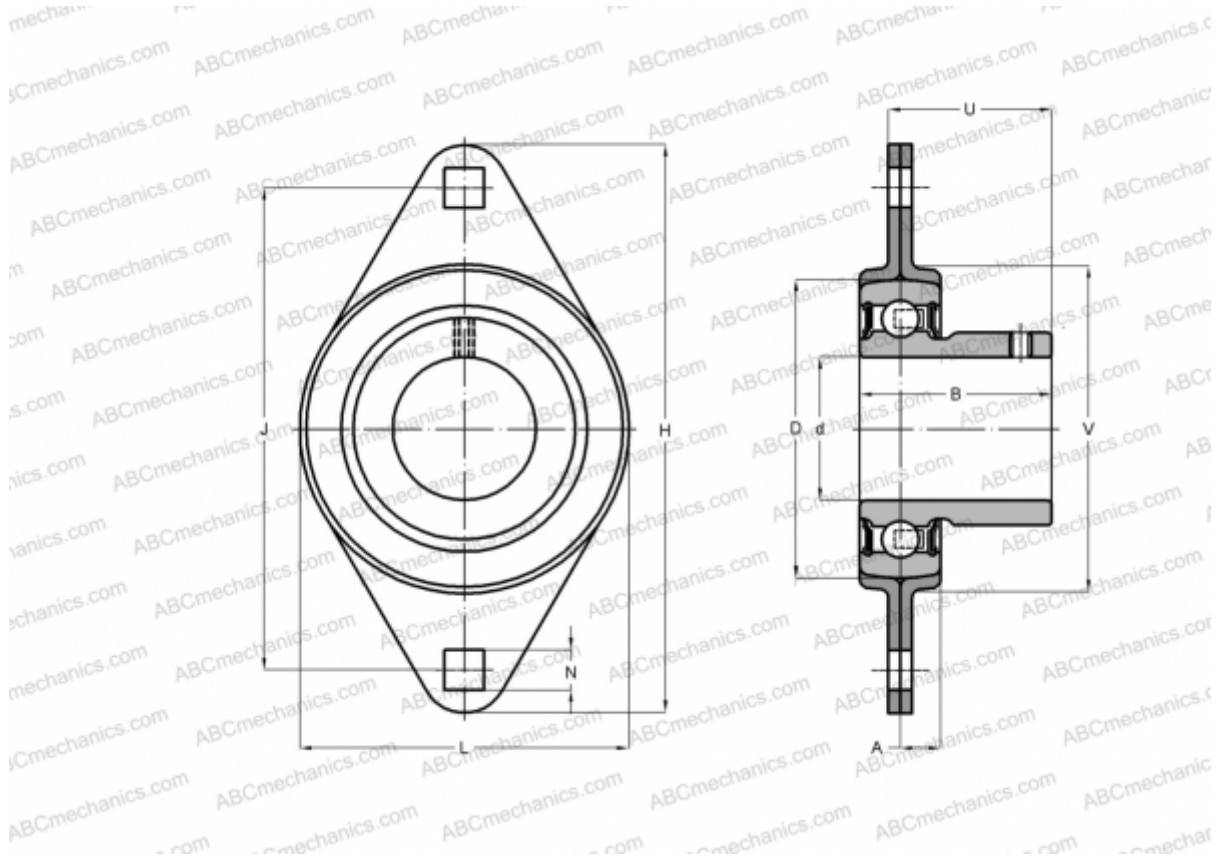

### Technical specification

#### DIMENSIONS, MM

d	17,000
D	40,000
B	22,000
L	59,000
H	81,000
A	7,000
J	63,500
N	7,000
V	49,000

**WEIGHT, KG** 0,220

Bearing	B 3
Housing	PFL 3

#### MANUFACTURER

[ASAHI](#)