

## BPFL 5 ASAHI

Ball bearing units

TYPE: Housing units, Two-bolt flanged housing units, Sheet steel housing, Radial insert ball bearing with grub screws in inner ring, Type BPFL (ASAHI)

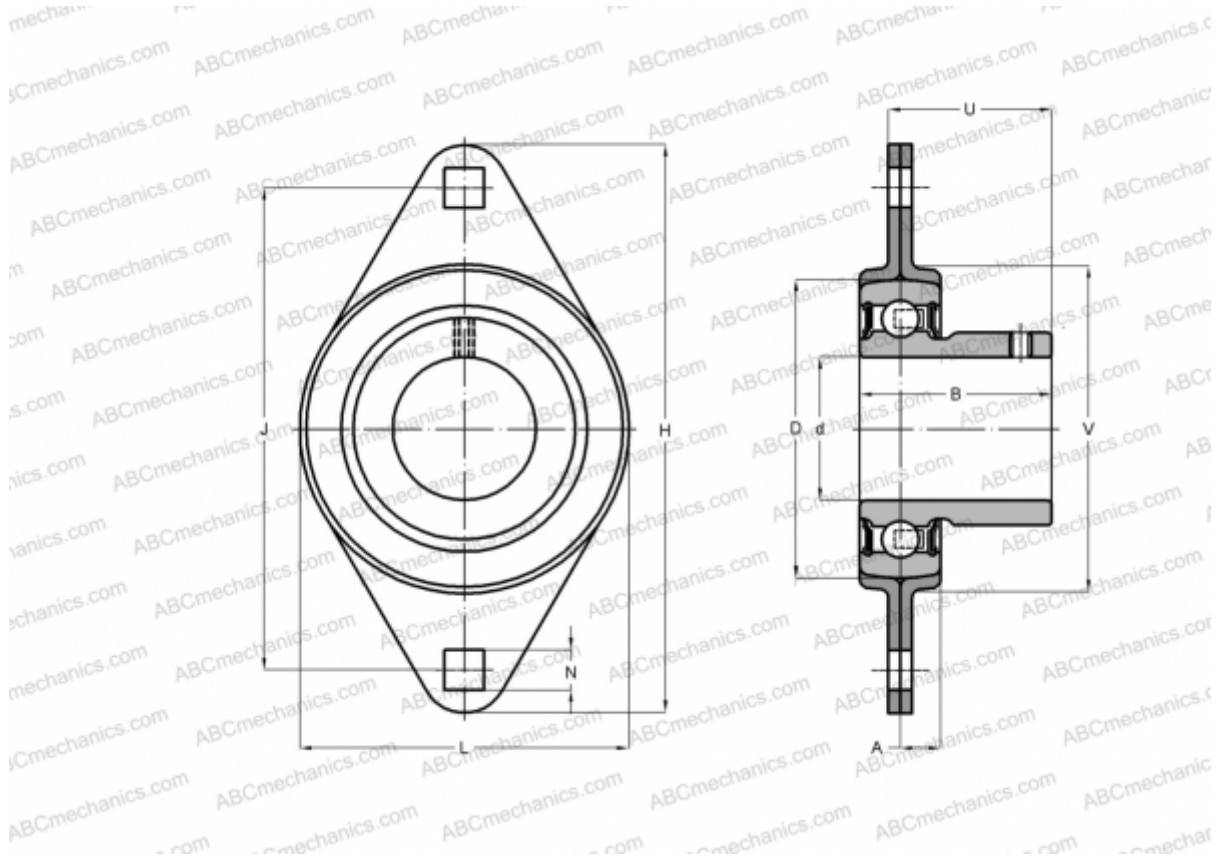

### Technical specification

#### DIMENSIONS, MM

d	25,000
D	52,000
B	27,000
L	71,000
H	95,000
A	9,000
J	76,000
N	9,000
V	60,000

**WEIGHT, KG** 0,360

Bearing	B 5
Housing	PFL 5

#### MANUFACTURER

[ASAHI](#)