

BPFL 6 ASAHI

Ball bearing units

TYPE: Housing units, Two-bolt flanged housing units, Sheet steel housing, Radial insert ball bearing with grub screws in inner ring, Type BPFL (ASAHI)

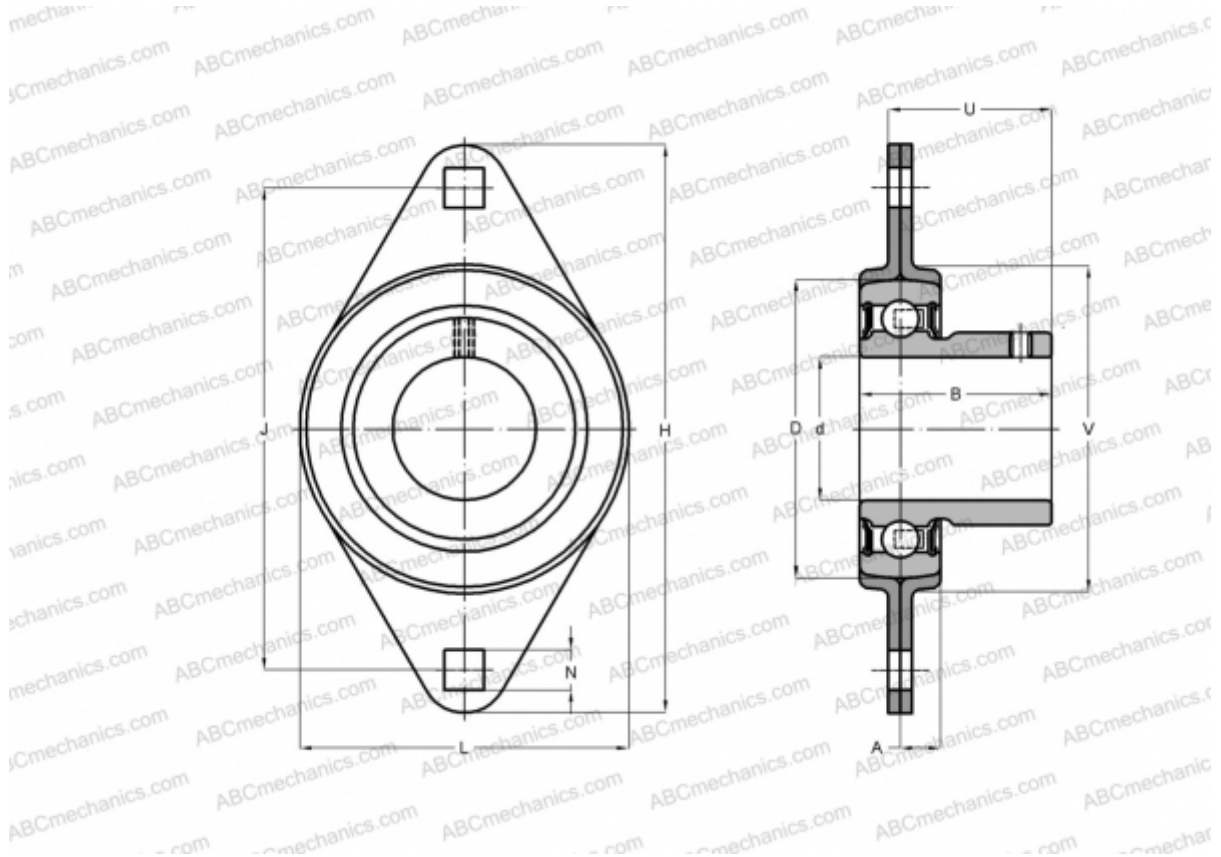

Technical specification

DIMENSIONS, MM

d	30,000
D	62,000
B	30,300
L	84,000
H	113,000
A	9,000
J	90,500
N	11,000
V	71,000

WEIGHT, KG 0,560

Bearing	B 6
Housing	PFL 6

MANUFACTURER

[ASAHI](#)