

BPFT 7 ASAHI

Ball bearing units

TYPE: Housing units, Three/four-bolt flanged housing units, Sheet steel housing, Radial insert ball bearing with grub screws in inner ring, Type BPFT (ASAHI)

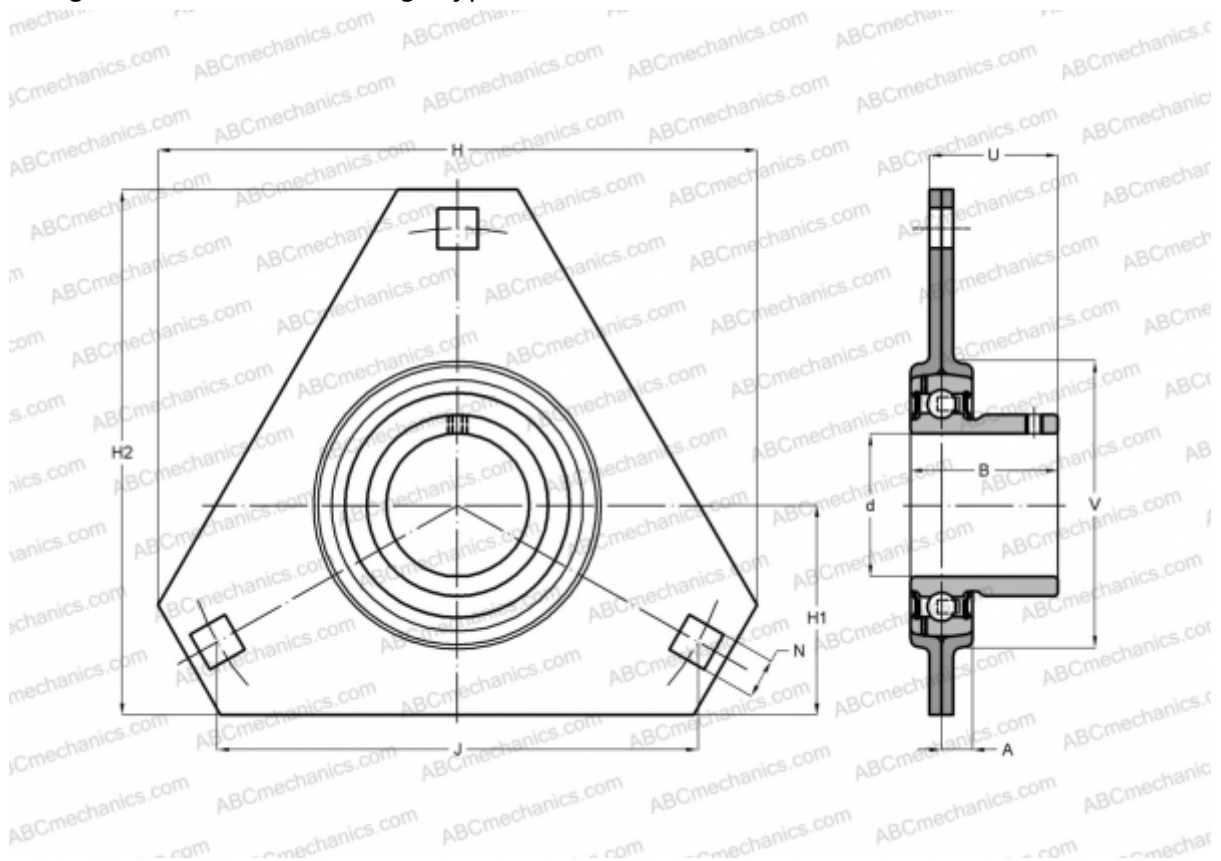

Technical specification

DIMENSIONS, MM

d	35,000
D	72,000
B	32,900
H	120,000
A	10,000
J	100,000
H1	45,000
N	11,000
V	81,000

WEIGHT, KG 0,710

Bearing	B 7
Housing	PFT 7

MANUFACTURER

[ASAHI](#)