

BF 204 ASAHI

Ball bearing units

TYPE: Housing units, Four-bolt flanged housing units, Cast iron housing, Radial insert ball bearing with grub screws in inner ring, Type BF (ASAHI)

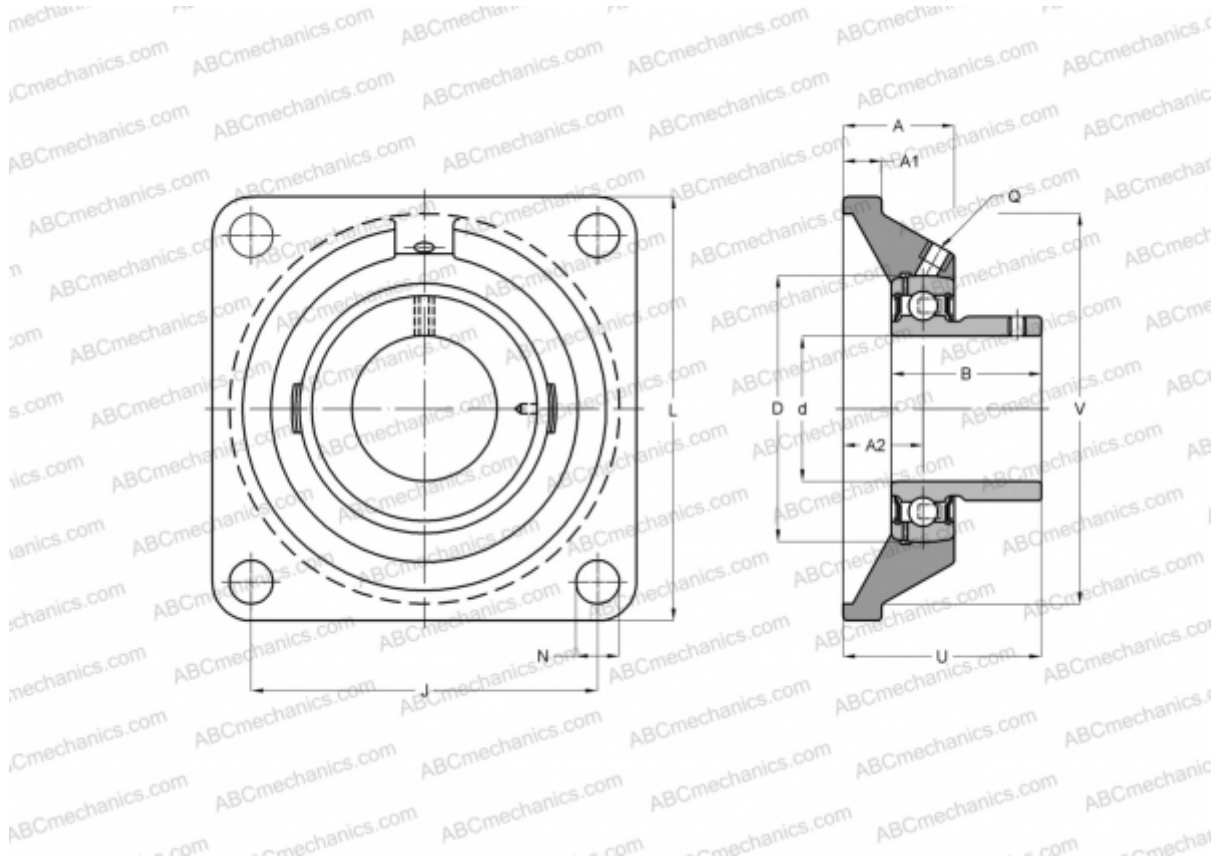

Technical specification

DIMENSIONS, MM

d	20,000
D	47,000
B	24,700
L	86,000
A	25,500
J	64,000
A1	12,000
A2	15,000
N	12,000
U	32,700

MANUFACTURER

[ASAHI](#)

WEIGHT, KG

0,550

Bearing	B 4
Housing	F 204