

BF 207 ASAHI

Ball bearing units

TYPE: Housing units, Four-bolt flanged housing units, Cast iron housing, Radial insert ball bearing with grub screws in inner ring, Type BF (ASAHI)

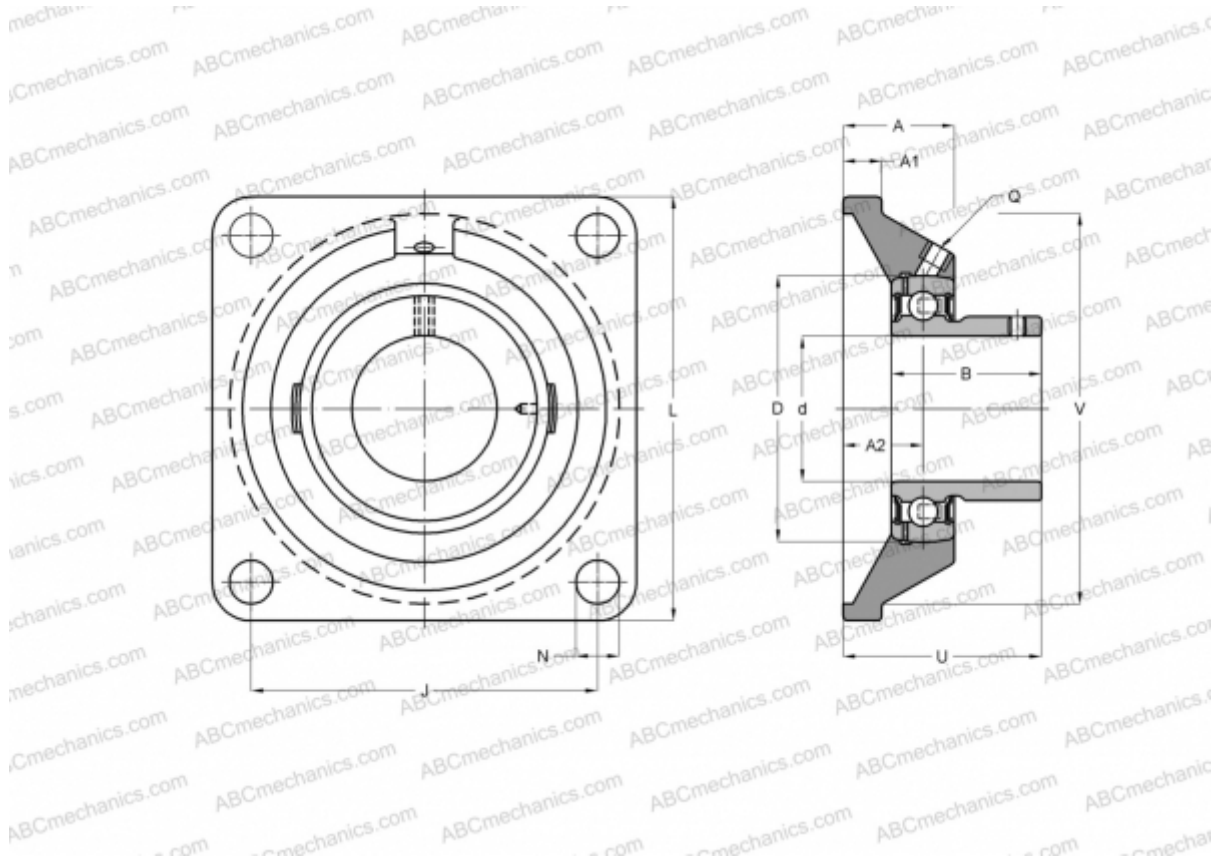

Technical specification

DIMENSIONS, MM

d	35,000
D	72,000
B	32,900
L	117,000
A	34,000
J	92,000
A1	16,000
A2	19,000
N	14,000
U	43,400

MANUFACTURER

[ASAHI](#)

WEIGHT, KG

1,500

Bearing	B 7
Housing	F 207