

UDF 206 ASAHI

Ball bearing units

TYPE: Housing units, Four-bolt flanged housing units, Cast iron housing, Radial insert ball bearing with eccentric locking collar, Type UDF (ASAHI)

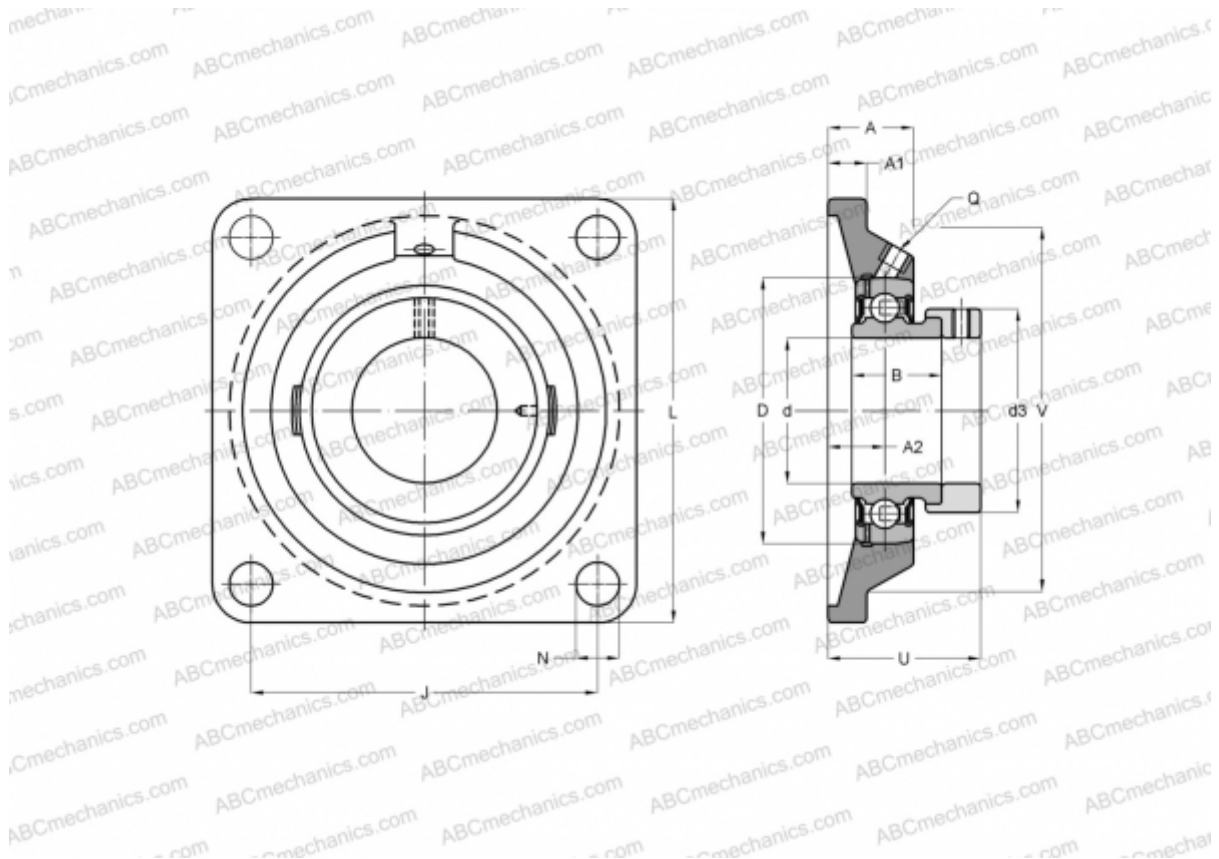

Technical specification

DIMENSIONS, MM

d	30,000
D	62,000
B	26,000
L	108,000
A	31,000
J	83,000
A1	14,000
A2	18,000
N	12,000
d3	40,000
U	41,000

WEIGHT, KG 1,100

Bearing UD206 + EE

Housing

MANUFACTURER

F 206

[ASAHI](#)