

UDFC 204 ASAHI

Ball bearing units

TYPE: Housing units, Four-bolt flanged housing units, Cast iron housing, Radial insert ball bearing with eccentric locking collar, Type UDFC (ASAHI)

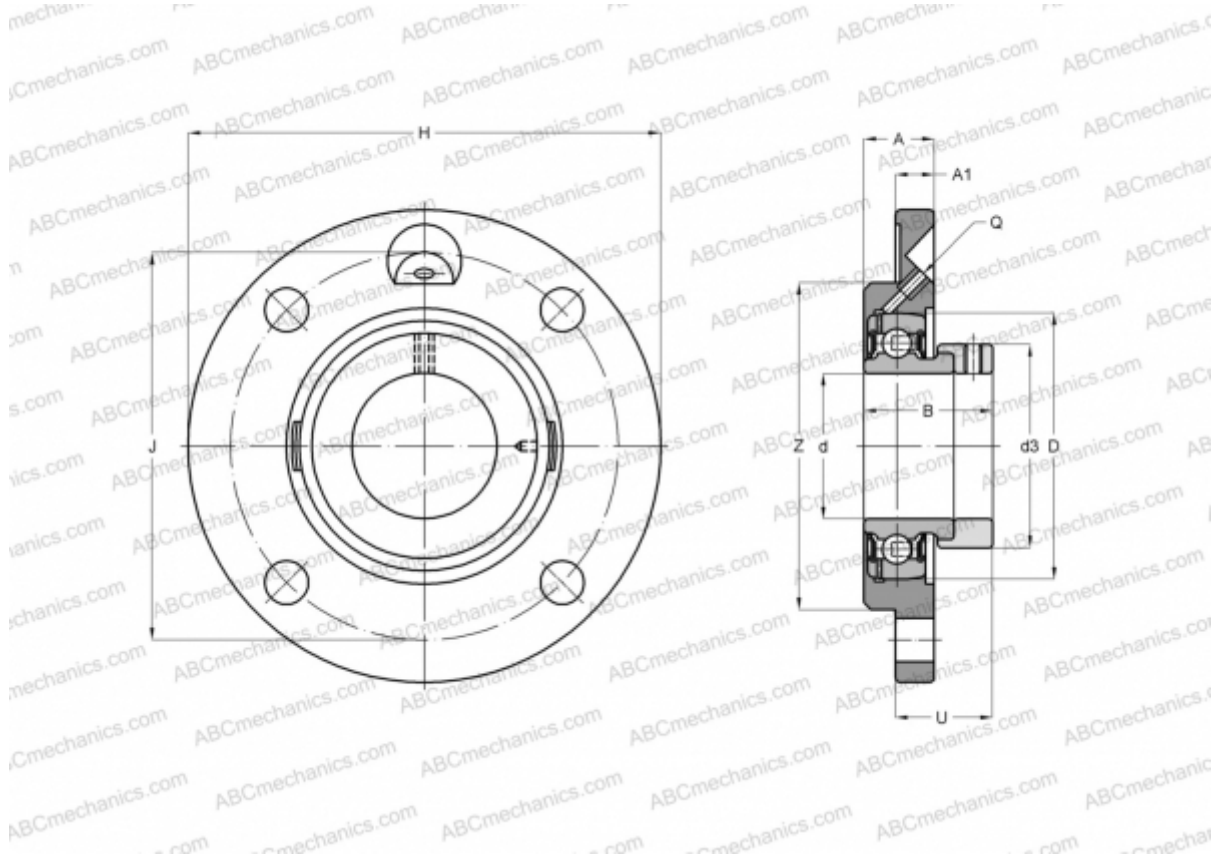

Technical specification

DIMENSIONS, MM

d	20,000
D	47,000
B	31,000
H	100,000
A	20,500
J	78,000
A1	7,000
N	12,000
d3	29,000
U	29,500
Z	62,000

WEIGHT, KG 0,840

Bearing UD 204 + EE

Housing

FC 204

MANUFACTURER

[ASAHI](#)