

UDFC 205 ASAHI

Ball bearing units

TYPE: Housing units, Four-bolt flanged housing units, Cast iron housing, Radial insert ball bearing with eccentric locking collar, Type UDFC (ASAHI)

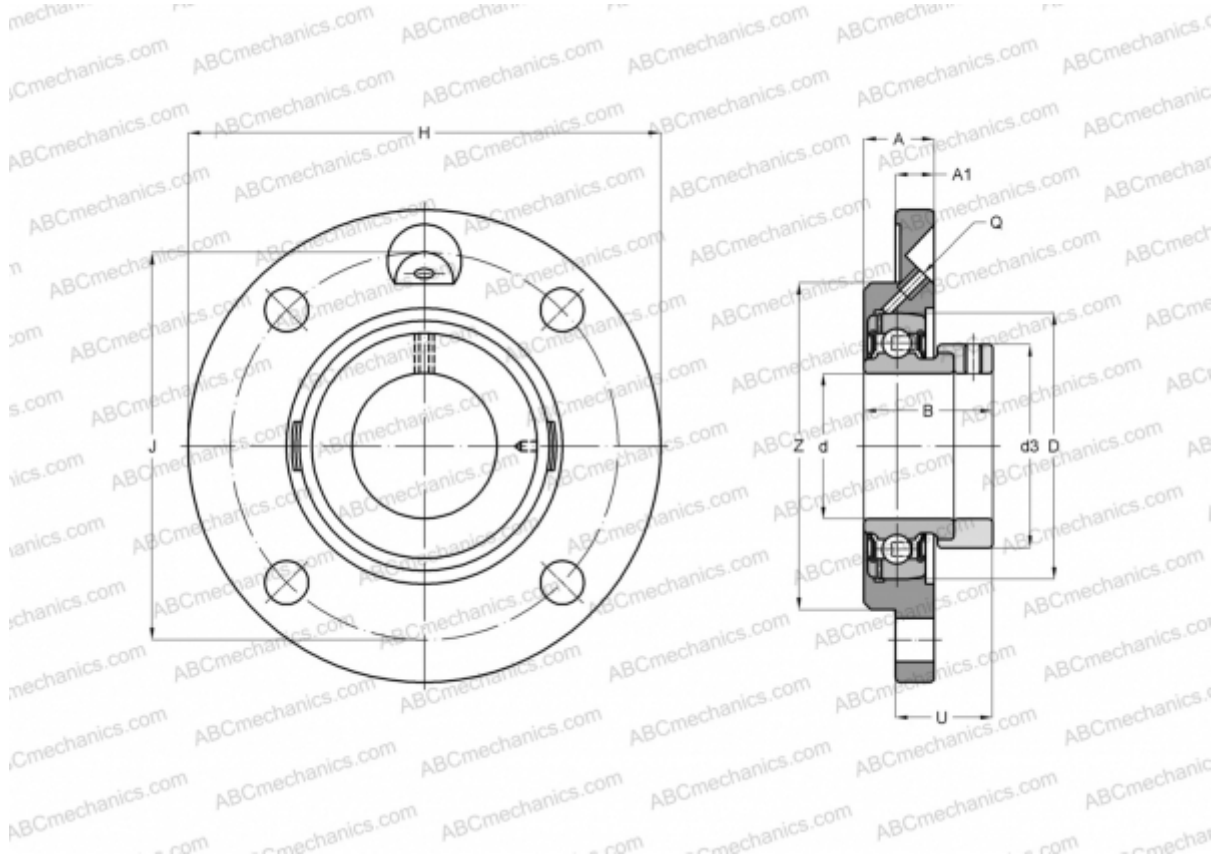

Technical specification

DIMENSIONS, MM

d	25,000
D	52,000
B	32,000
H	115,000
A	21,000
J	90,000
A1	7,000
N	12,000
d3	34,000
U	30,500
Z	70,000

WEIGHT, KG 1,100

Bearing UD 205 + EE

Housing

FC 205

MANUFACTURER

[ASAHI](#)