

UDFC 210 ASAHI

Ball bearing units

TYPE: Housing units, Four-bolt flanged housing units, Cast iron housing, Radial insert ball bearing with eccentric locking collar, Type UDFC (ASAHI)

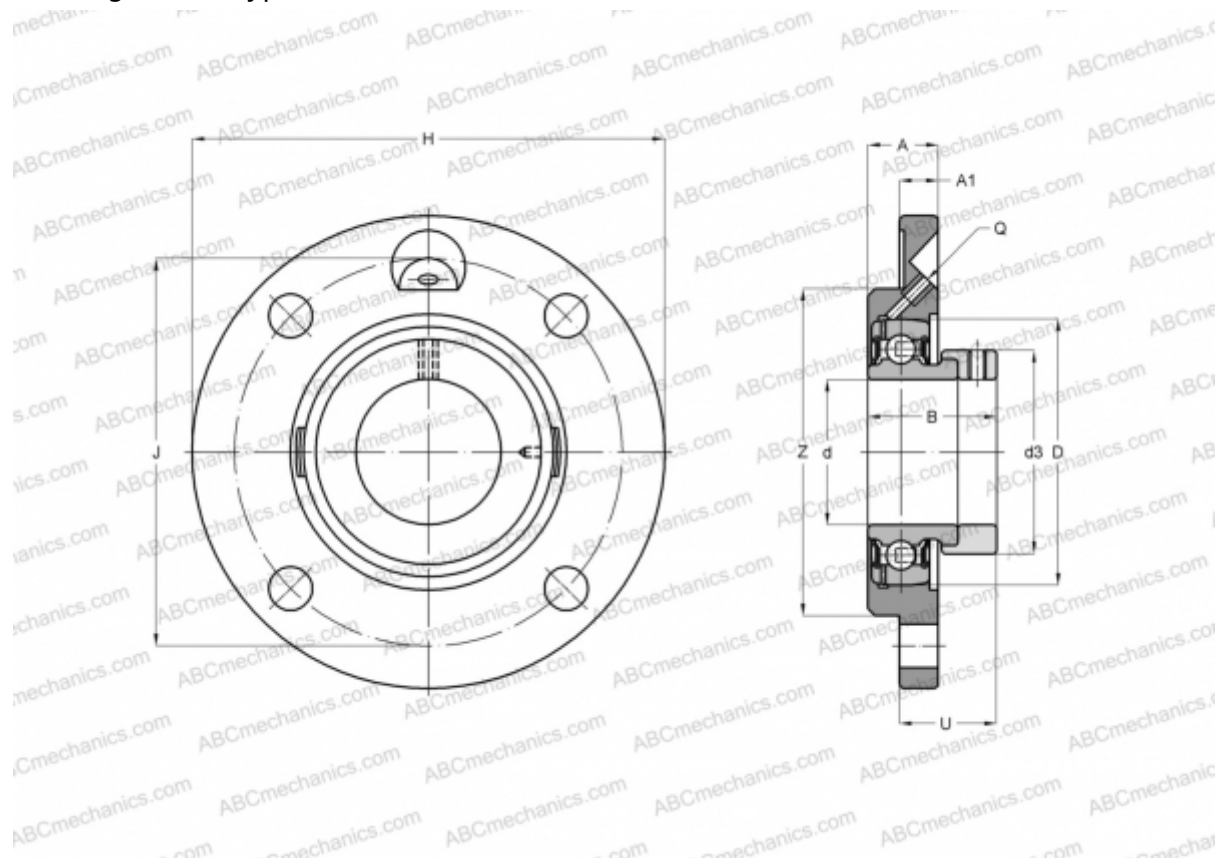

Technical specification

DIMENSIONS, MM

d	50,000
D	90,000
B	43,000
H	165,000
A	28,000
J	138,000
A1	14,000
N	16,000
d3	63,000
U	37,500
Z	110,000

WEIGHT, KG 3,100

Bearing UD 210 + EE

Housing

FC 210

MANUFACTURER

[ASAHI](#)