

## UCF 201 ASAHI

Ball bearing units

TYPE: Housing units, Four-bolt flanged housing units, Cast iron housing, Radial insert ball bearing with grub screws in inner ring, Type UCF (ASAHI)

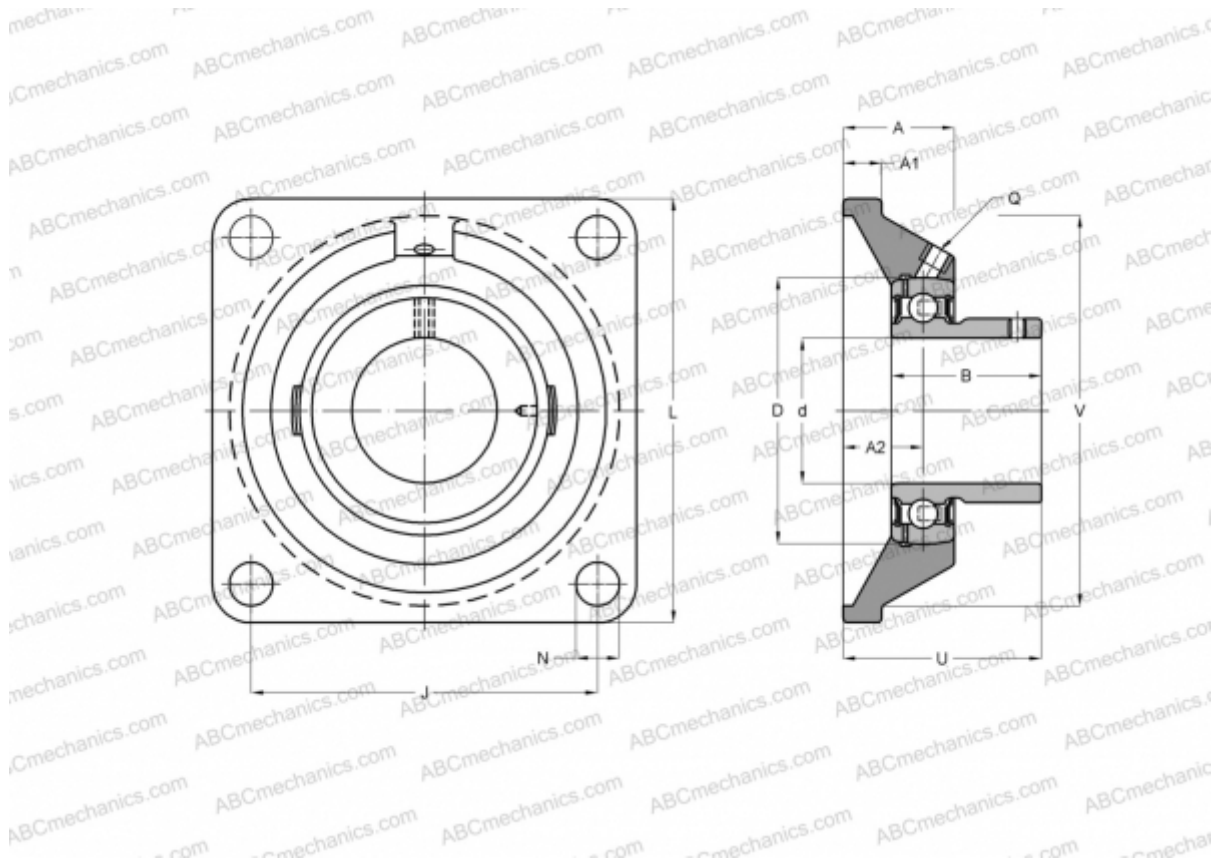

### Technical specification

#### DIMENSIONS, MM

d	12,000
D	47,000
B	31,000
L	86,000
A	25,500
J	64,000
A1	12,000
A2	15,000
N	12,000
U	33,300

#### MANUFACTURER

[ASAHI](#)

#### WEIGHT, KG

0,640

Bearing	UC 201
Housing	F 204