

UCF 206 ASAHI

Ball bearing units

TYPE: Housing units, Four-bolt flanged housing units, Cast iron housing, Radial insert ball bearing with grub screws in inner ring, Type UCF (ASAHI)

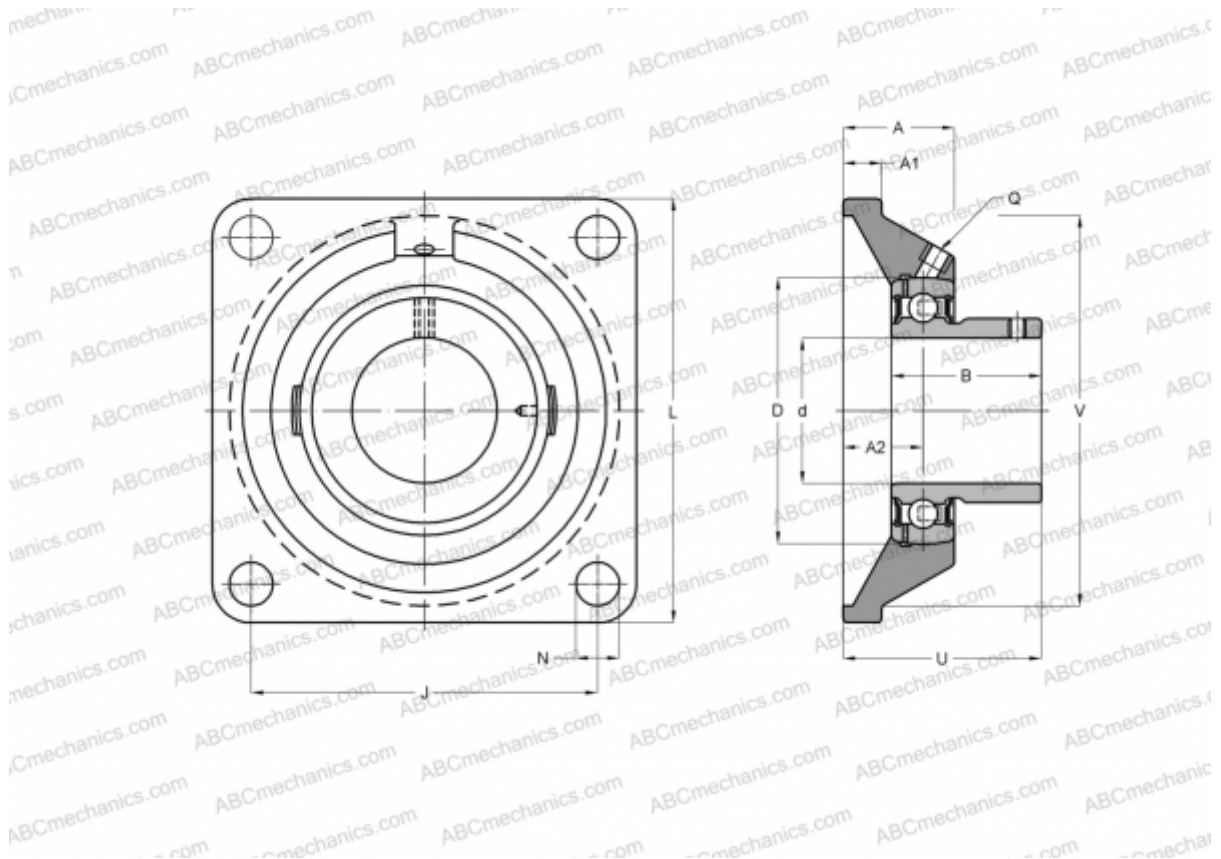

Technical specification

DIMENSIONS, MM

d	30,000
D	62,000
B	38,100
L	108,000
A	31,000
J	83,000
A1	14,000
A2	18,000
N	12,000
U	40,200

MANUFACTURER

[ASAHI](#)

WEIGHT, KG

1,100

Bearing	UC 206
Housing	F 206