

## UCF 208 ASAHI

Ball bearing units

TYPE: Housing units, Four-bolt flanged housing units, Cast iron housing, Radial insert ball bearing with grub screws in inner ring, Type UCF (ASAHI)

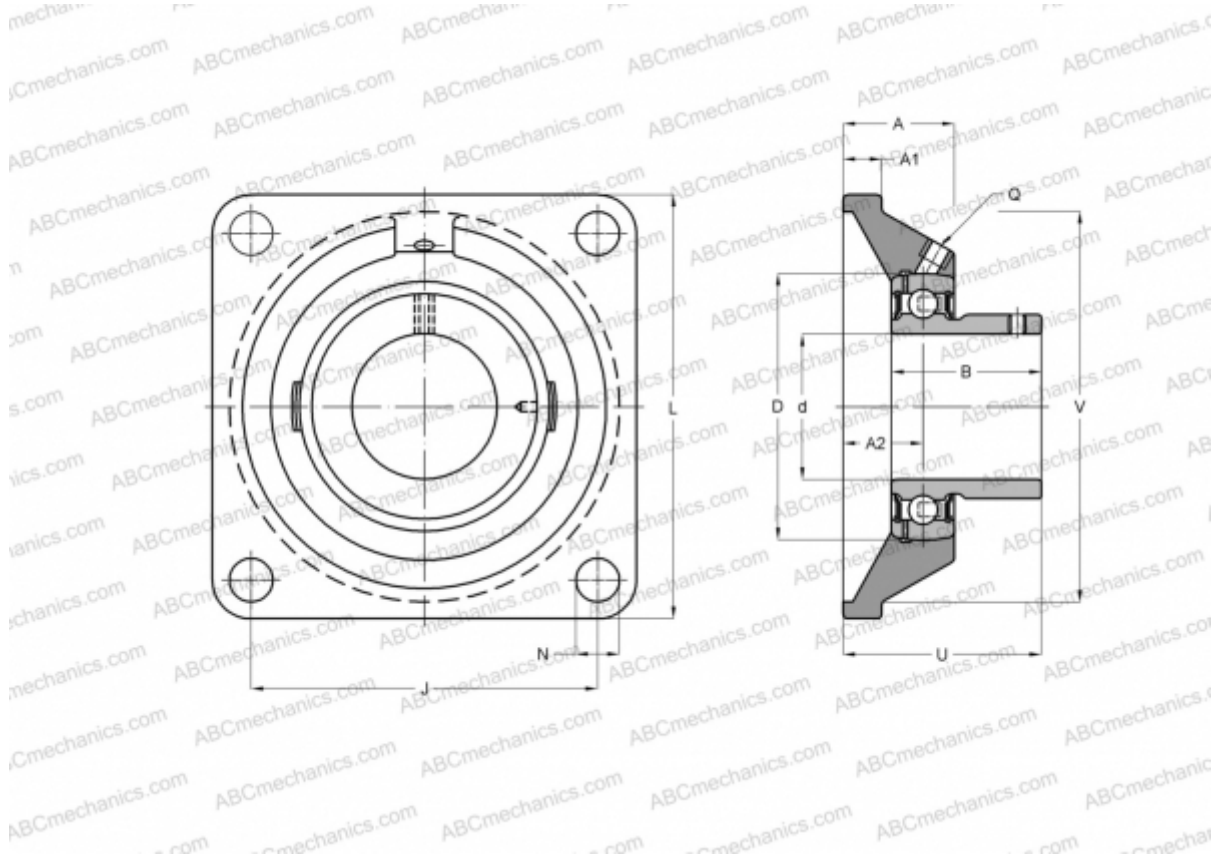

### Technical specification

#### DIMENSIONS, MM

d	40,000
D	80,000
B	49,200
L	130,000
A	36,000
J	102,000
A1	16,000
A2	21,000
N	16,000
U	51,200

#### MANUFACTURER

[ASAHI](#)

#### WEIGHT, KG

2,000

Bearing	UC 208
Housing	F 208