

UCF 210 ASAHI

Ball bearing units

TYPE: Housing units, Four-bolt flanged housing units, Cast iron housing, Radial insert ball bearing with grub screws in inner ring, Type UCF (ASAHI)

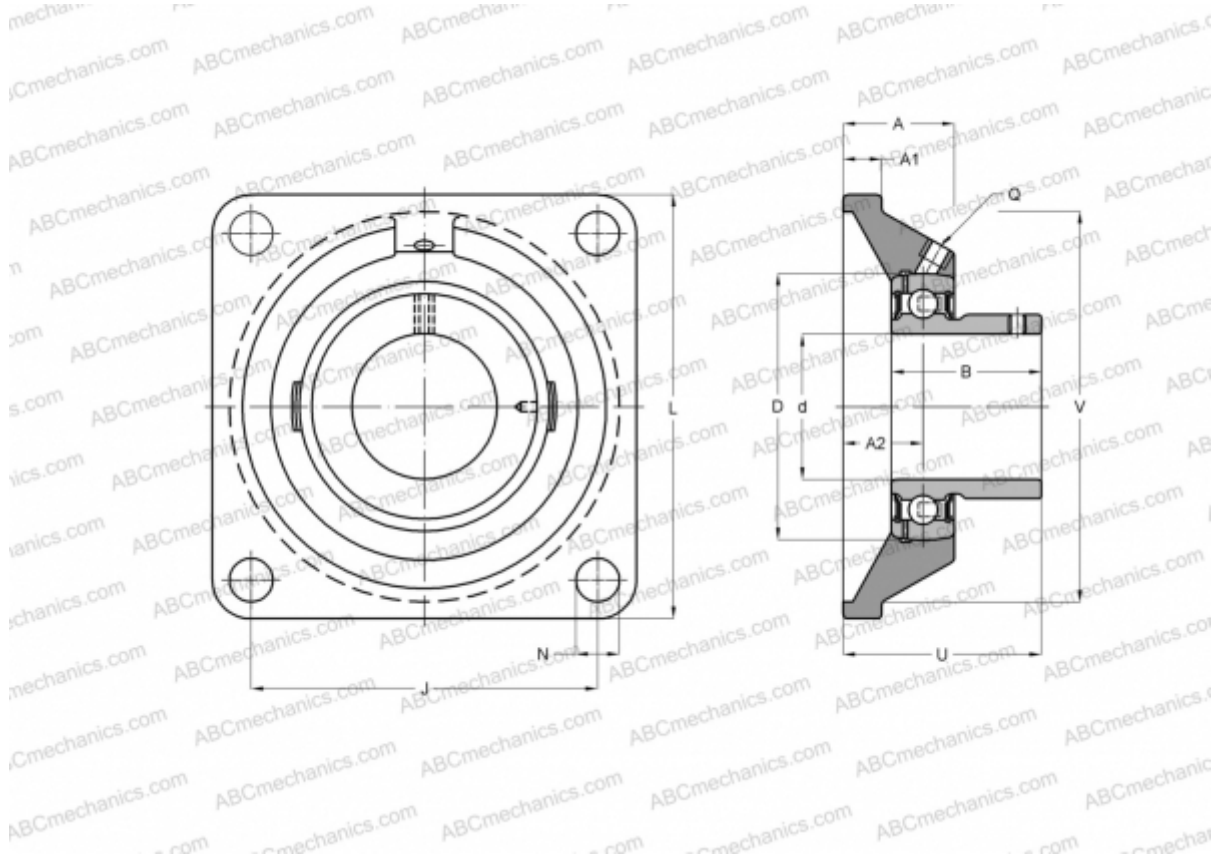

Technical specification

DIMENSIONS, MM

d	50,000
D	90,000
B	51,600
L	143,000
A	40,000
J	111,000
A1	18,000
A2	22,000
N	16,000
U	54,600

MANUFACTURER

[ASAHI](#)

WEIGHT, KG

2,500

Bearing	UC 210
Housing	F 210