

UCF 212 ASAHI

Ball bearing units

TYPE: Housing units, Four-bolt flanged housing units, Cast iron housing, Radial insert ball bearing with grub screws in inner ring, Type UCF (ASAHI)

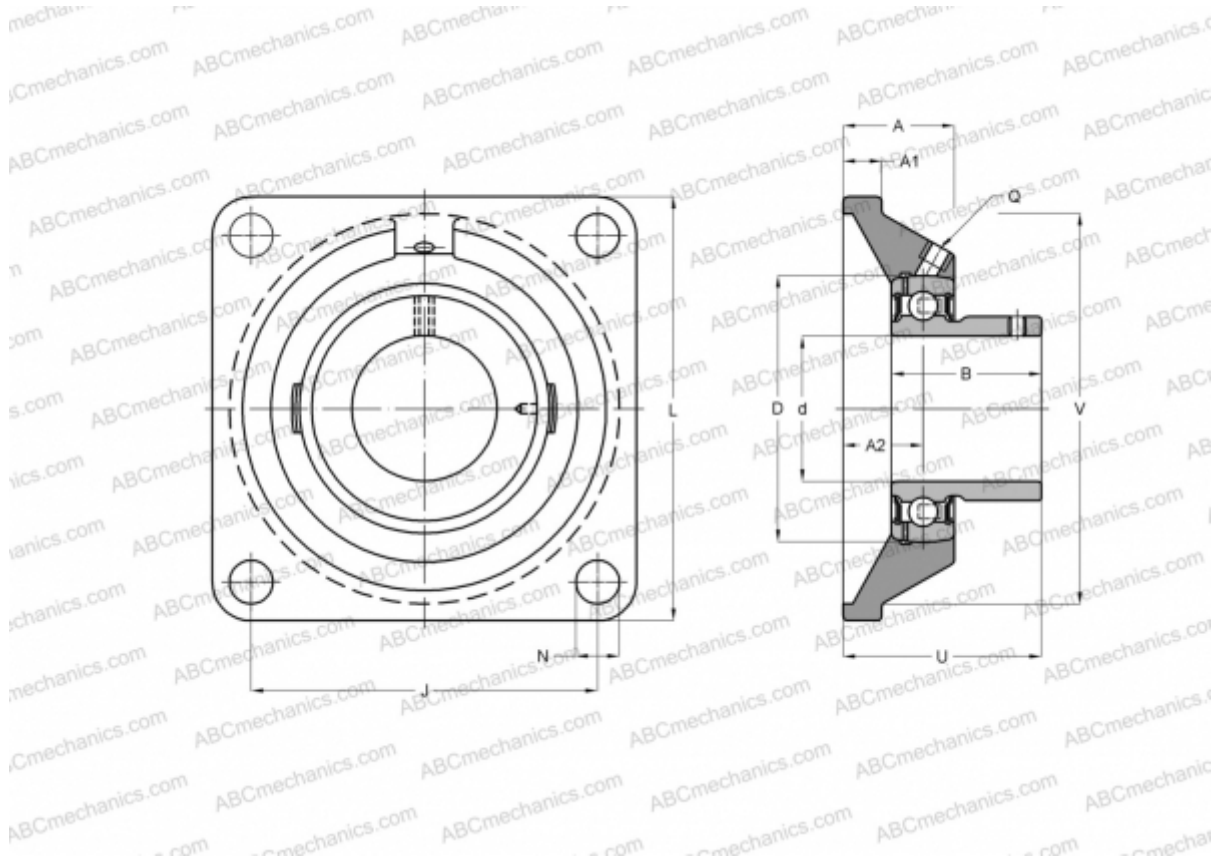

Technical specification

DIMENSIONS, MM

d	60,000
D	110,000
B	65,100
L	175,000
A	48,000
J	143,000
A1	20,000
A2	29,000
N	19,000
U	68,700

MANUFACTURER

[ASAHI](#)

WEIGHT, KG

4,600

Bearing	UC 212
Housing	F 212