

## UCF 213 ASAHI

Ball bearing units

TYPE: Housing units, Four-bolt flanged housing units, Cast iron housing, Radial insert ball bearing with grub screws in inner ring, Type UCF (ASAHI)

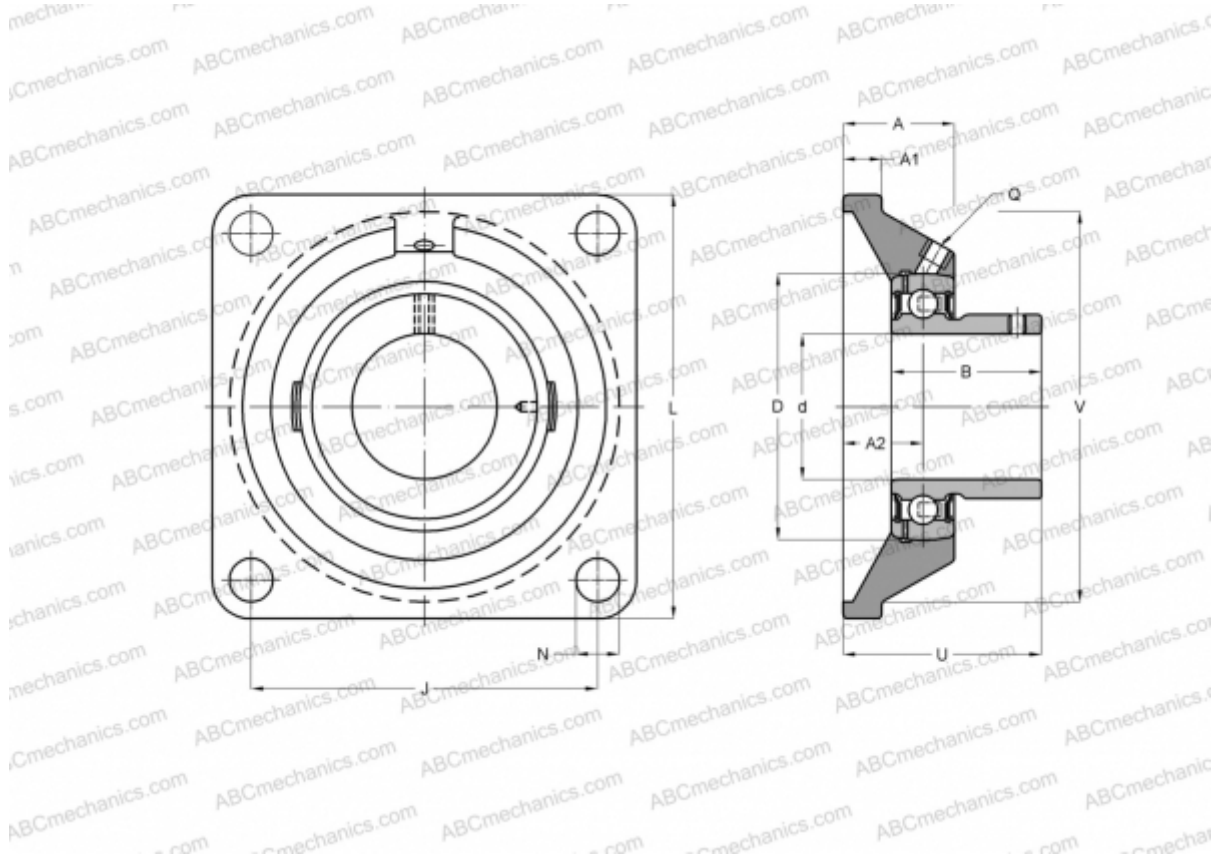

### Technical specification

#### DIMENSIONS, MM

d	65,000
D	120,000
B	65,100
L	187,000
A	50,000
J	149,000
A1	20,000
A2	30,000
N	19,000
U	69,700

#### MANUFACTURER

[ASAHI](#)

#### WEIGHT, KG

5,500

Bearing	UC 213
Housing	F 213