

UCF 214 ASAHI

Ball bearing units

TYPE: Housing units, Four-bolt flanged housing units, Cast iron housing, Radial insert ball bearing with grub screws in inner ring, Type UCF (ASAHI)

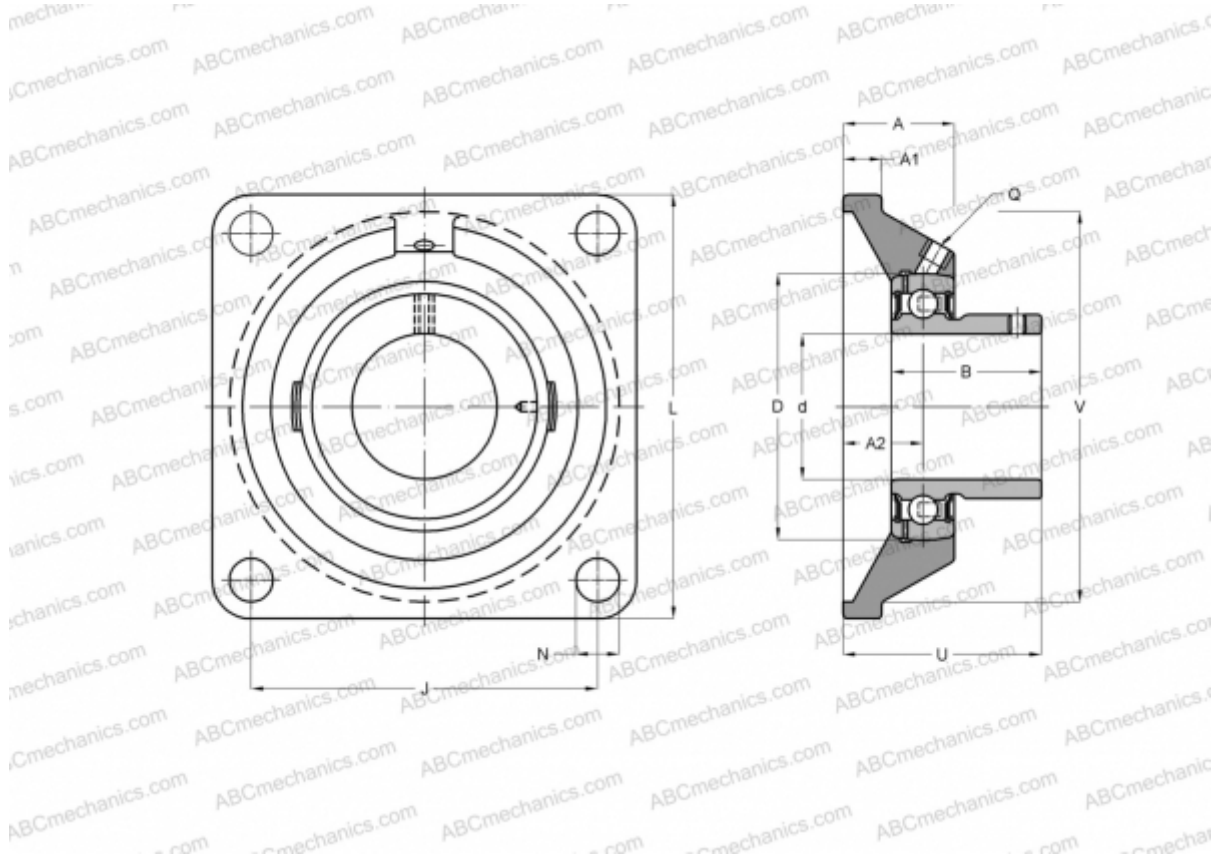

Technical specification

DIMENSIONS, MM

d	70,000
D	125,000
B	74,600
L	193,000
A	54,000
J	152,000
A1	24,000
A2	31,000
N	19,000
U	75,400

MANUFACTURER

[ASAHI](#)

WEIGHT, KG

6,100

Bearing	UC 214
Housing	F 214