

UCF 215 ASAHI

Ball bearing units

TYPE: Housing units, Four-bolt flanged housing units, Cast iron housing, Radial insert ball bearing with grub screws in inner ring, Type UCF (ASAHI)

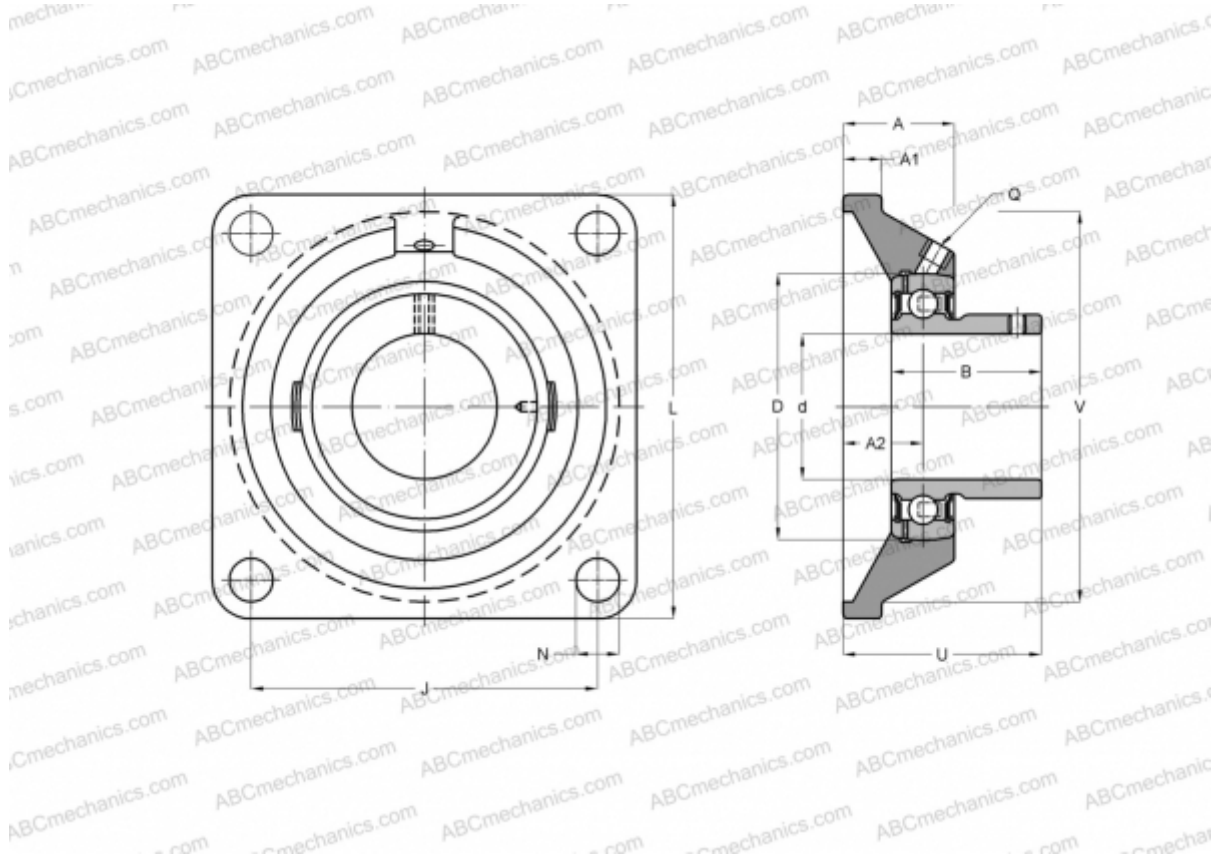

Technical specification

DIMENSIONS, MM

d	75,000
D	130,000
B	77,800
L	200,000
A	56,000
J	159,000
A1	24,000
A2	34,000
N	19,000
U	78,500

MANUFACTURER

[ASAHI](#)

WEIGHT, KG

6,900

Bearing	UC 215
Housing	F 215