

## UCF 217 ASAHI

Ball bearing units

TYPE: Housing units, Four-bolt flanged housing units, Cast iron housing, Radial insert ball bearing with grub screws in inner ring, Type UCF (ASAHI)

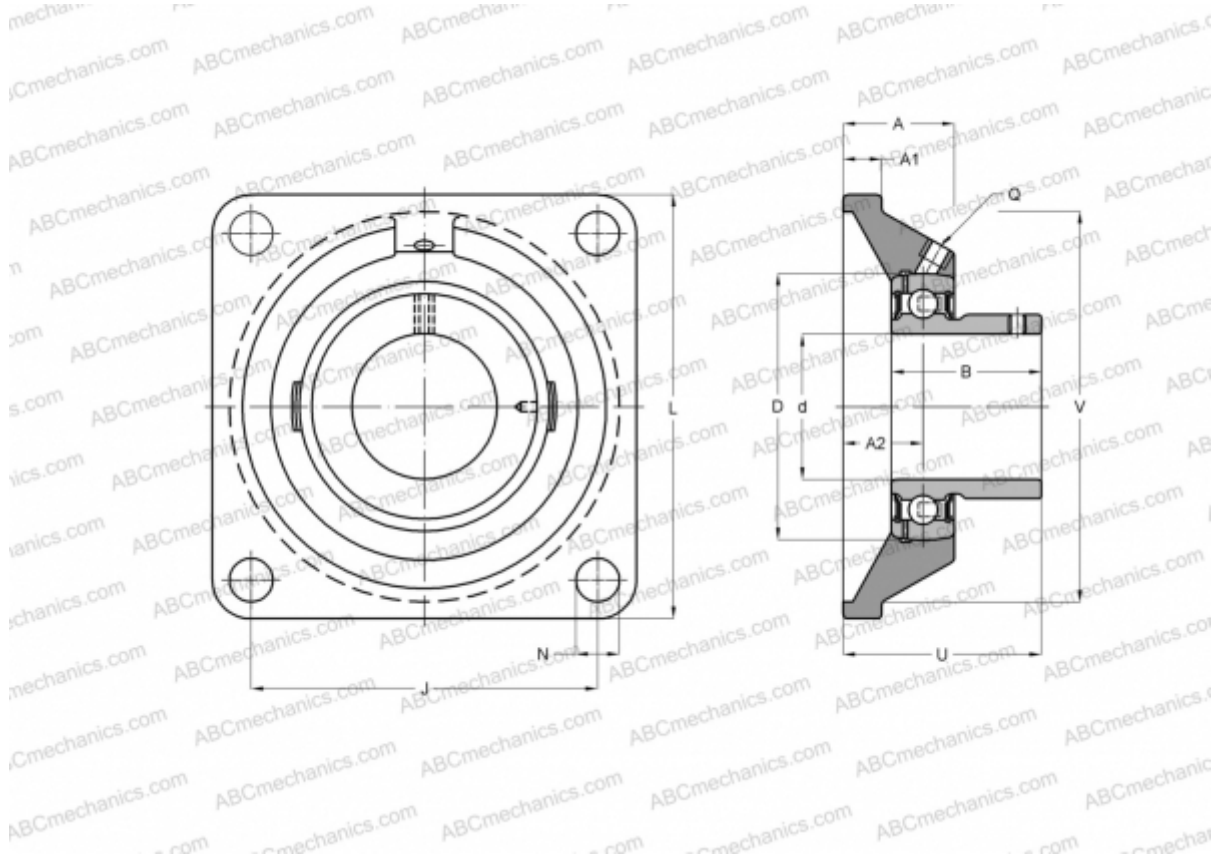

### Technical specification

#### DIMENSIONS, MM

d	85,000
D	150,000
B	85,700
L	220,000
A	63,000
J	175,000
A1	26,000
A2	36,000
N	23,000
U	87,600

#### MANUFACTURER

[ASAHI](#)

#### WEIGHT, KG

9,300

Bearing	UC 217
Housing	F 217