

UCF 218 ASAHI

Ball bearing units

TYPE: Housing units, Four-bolt flanged housing units, Cast iron housing, Radial insert ball bearing with grub screws in inner ring, Type UCF (ASAHI)

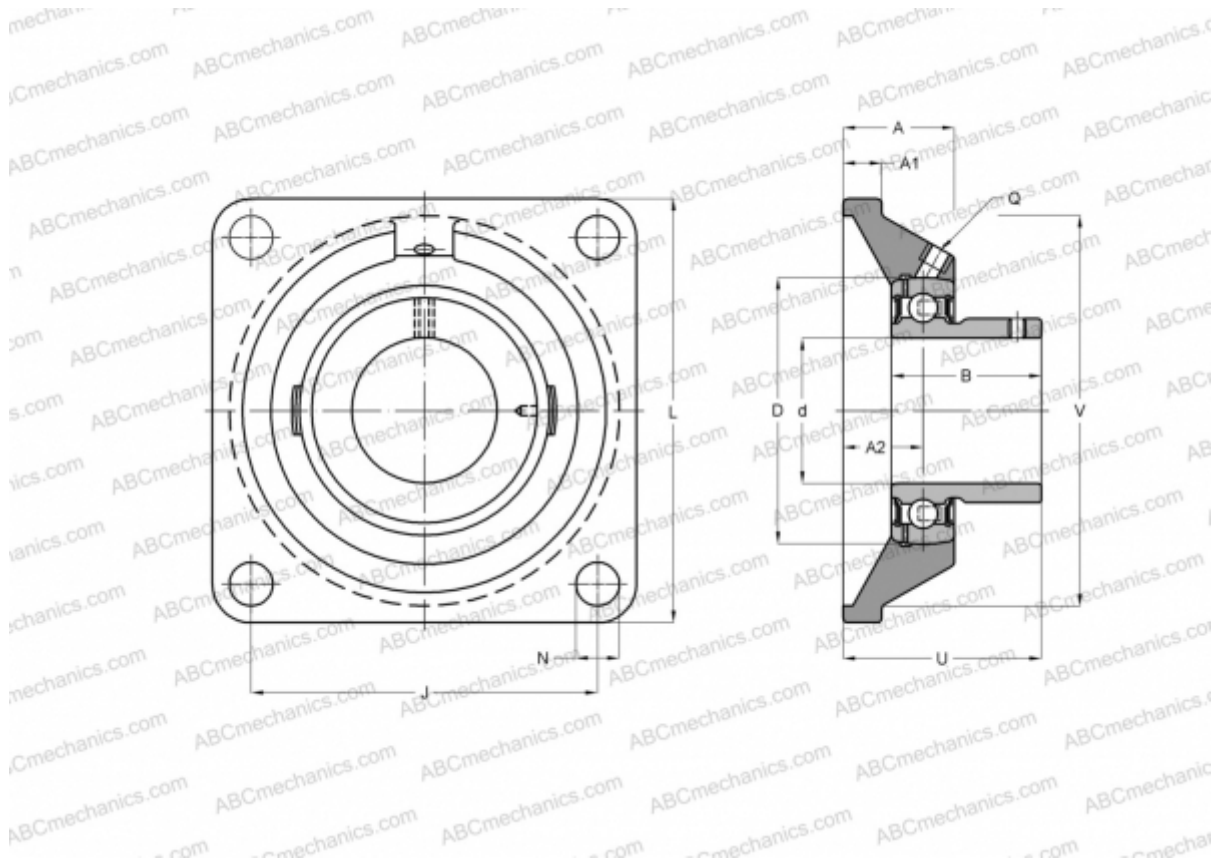

Technical specification

DIMENSIONS, MM

d	90,000
D	160,000
B	96,000
L	235,000
A	68,000
J	187,000
A1	26,000
A2	40,000
N	23,000
U	96,300

MANUFACTURER

[ASAHI](#)

WEIGHT, KG

11,300

Bearing	UC 218
Housing	F 218