

UCF 305 ASAHI

Ball bearing units

TYPE: Housing units, Four-bolt flanged housing units, Cast iron housing, Radial insert ball bearing with grub screws in inner ring, Type UCF (ASAHI)

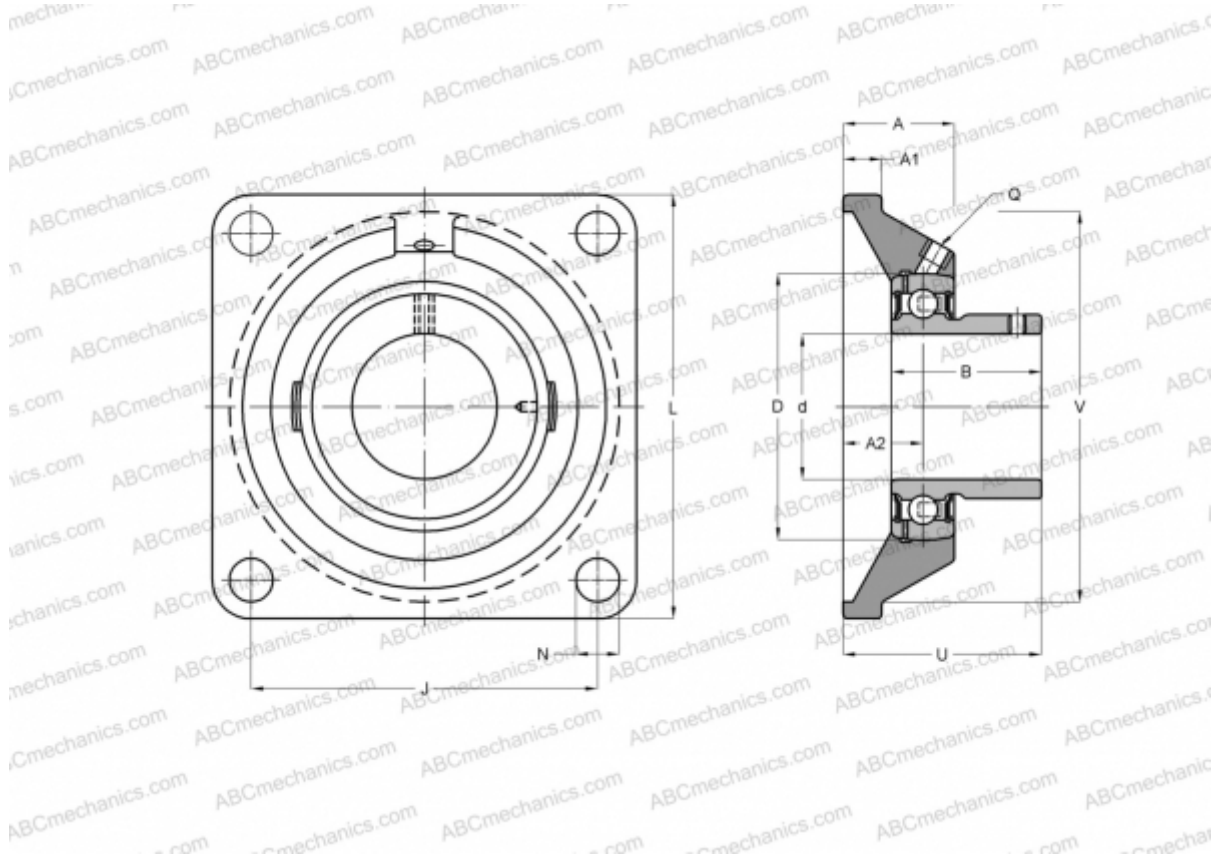

Technical specification

DIMENSIONS, MM

d	25,000
D	62,000
B	38,000
L	110,000
A	29,000
J	80,000
A1	13,000
A2	16,000
N	16,000
U	39,000

MANUFACTURER

[ASAHI](#)

WEIGHT, KG

1,200

Bearing	UC 305
Housing	F 305